

***Fabric of The Universe:
The Origins, Implications, and Applications
of Vastu Science***

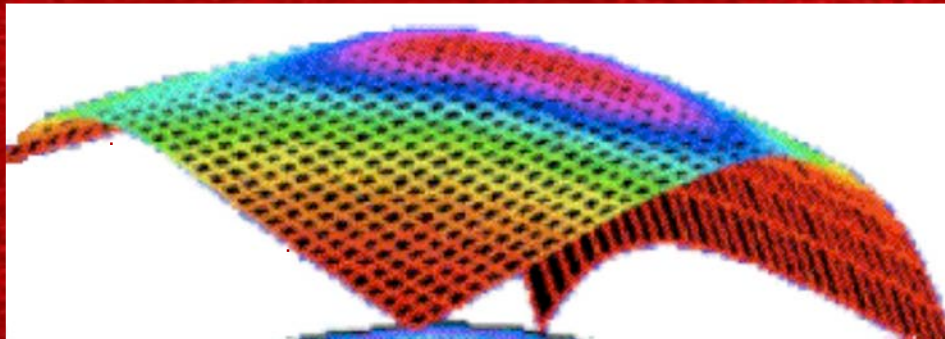

Jessie J. Mercay, ND, PhD, PhD mst

COPYRIGHT DATA

About the ebooks:

The present ebook is made available by the Spiritist ebook team with the objective of offering content for partial use in research and studies, as well as a simple test of the literary's work quality, with the exclusive purpose of future purchase.

The sale, rental, or any commercial use of this content is expressly prohibited and totally repudiated.

About Us:

The Spiritist ebook makes public domain and intellectual property content available completely free of charge, as it believes that Spiritist knowledge and education should be accessible and free to anyone and everyone. You can find more ebooks on our website: www.ebookespirita.org



www.ebookespirita.org

**Fabric of The Universe:
The Origins, Implications, and Applications
of Vastu Science**

By

Jessie J. Mercay, ND, PhD, PhD mst

Published by
Dakshinaa Publishing House
Number 46, First Avenue
Vettuvankeni, Chennai – 41
India, (Tamilnadu)
Phone: (044) 24491384; 24492651

Publisher: Dr. V. Ganapati Sthapati

First Edition: May 2006
Second Edition: June 2007
Third Edition: March 2008

Price:
India and Asia: Rs. 250
Europe and the Americas: \$14.95 US

Purchase:
In India and Asia
Dakshinaa Publishing House
Number 46, First Avenue
Vettuvankeni, Chennai – 41
India, (Tamilnadu)
Phone: (044) 24491384; 24492651

In Europe and The Americas:
jmercay@vastu2vaastu.com
www.vastu2vaastu.com
www.aumscience.com

Copyright 2005, Dr. Jessie J. Mercay, 3819 Silver Plume Circle, Boulder, CO,
USA jmercay@vastu2vaastu.com. No part of this document may be copied or
transmitted without the explicit permission of the author.

Acknowledgments

I would like to take this opportunity to thank a number of people for their help and support. Their contributions are numerous and their love and support were most welcomed. First and foremost I want to offer my deepest honor and respect to Mamuni Mayan who, through deep introspection, revealed to humankind the knowledge that we call Mayonic Science and Technology. Second I would like to thank Dr. V. Ganapati Sthapati and his entire family tradition of Sthapatis and Shipis who, for over 1000 years, have been the agents for passing down this ancient knowledge in its purest form. Dr. Sthapati's deep insights, willingness to share, and continued support were instrumental in inspiring me to go deeply into myself to comprehend aspects of this knowledge that have not been written for thousands of years. His guidance, mentorship, intelligence, blessings and warmth made it possible for me to produce this document.

In addition I would like to thank Claire Love and Marguerite Wilson for their editing and other suggestions. I would also like to thank Karen Kelly, Brian Dolan and Karen Amber Terrill for their love, support and encouragement. I thank Mimi Tinetti and Phil Thyen for their generosity . Because of them, I was able to continue my studies in Mayonic Science and Technology. I would also like to thank Dr. Chao Li for his ongoing support in delving into the ancient science and technology of built space. I also want to thank Arch. Krithika, for her suggestions. Last but not least, I want to thank Amma and the entire staff of the Vastu Vedic Research Foundation for their untiring support during my studies in Kauai and Chennai with Dr. V. Ganapati Sthapati.

The life and teachings of Maharishi Mahesh Yogi have influenced me in innumerable ways.

For this Edition I would like to thank the students of The American University of Mayonic Science and Technology for their enthusiasm, commitment, and love for this deep knowledge.

I have attempted to acknowledge my sources for quotes and diagrams. In some cases I might have failed at the task and ask for forgiveness if I have failed to do so. Upon notification I will immediately interject acknowledgement in the next edition.

Dedication

I dedicate this book to my parents, Lorange Mercay and Jessie Patty Mercay. The attributes that they passed on to me allowed me to have the insights that I have had in this text. My mother was an educator and encouraged the importance of gaining knowledge. My father (still living and working at almost 92 years young) was a farmer and taught me to love and respect nature. Both of my parents maintained their own spiritual nature and ultimately understood that I have my own path. It was during my early years as a child growing up in the silence of nature that I had an authentic awakening and experiences of deep understanding regarding the oneness of all creation – manifest and unmanifest. Those experiences gave me my first glimpse of Vastu. I am grateful that my parents provided me with the environment for those experiences.

I would also like to dedicate this to the father of Dr. V. Ganapati Sthapati: Sri Vaidyanatha Sthapati, a renowned Sthapati and Sanskrit scholar. The priceless knowledge that he so carefully passed on to his son and preserved in the forms, large and small, that he built and fashioned, has contributed immeasurably to the preservation and revelation of Mayonic Science and Technology. His insight and brilliance helped to bring this knowledge forward for this time.

Note: This document began as a thesis presented to the Vedic Research Foundation, Chennai directed by Dr. V. Ganapati Sthapati, for which I was awarded a Doctorate in Mayonic Science and Technology (Ph.D. mst).

The present edition is expanded and contains new information. Some of the information contained within has never been published in modern times and was developed from my own introspection. It has been carefully reviewed, verified and found to be accurate by Dr. V. Ganapati Sthapati prior to publication. The physics of Mayonic Science, the Mayonic Code, finer details of Mayans use of the word Kaalam, the details of the additive process of manifestation and other revelations are some of the topics uncovered by me and verified by Dr. V. Ganapati Sthapati. This new version will continue to be developed and will eventually be used as a text for the newly established American University of Mayonic Science and Technology (www.aumscience.com).

Foreword

I take immense pride and satisfaction in writing this introduction for this Publication by Dr. Jessie Mercay, which captures the essence of “Vaastu Science” and presents this great Science and its Technology in a succinct package to the global community.

The contents of this Publication attest to the subtle but potent truth about the origin and continuing growth of Indian Culture. The fabric of Indian Culture is interwoven within the threads of Vaastu Science.

A key to understanding Indian Culture is to comprehend that it is this Vaastu Science that gives rise to the resultant Technology. On the contrary, in the case of Modern Science, it is the tenets of Technology which give rise to the Science. Vaastu Science embodies the onward universal journey from the Inner Subtle Nature to the Outer Gross Nature. In other words, the marked difference is that Vaastu Science is Spirit-centric and Modern Science, Matter-centric.

This Science, in its entirety and simplicity, when applied, enables us to live in harmony with the innate rhythm of Nature.

Dr. Jessie Mercay has thoroughly explained the origins of Universal Life and the Science behind it. Going one step further, her immense grasp of this Science has enabled her to expound very ably its applications in Building Architecture and its implications on human life.

As Shilpa Guru, I bless Dr. Jessie for her inimitable contribution to the essence of Indian Culture.

Dr. V. Ganapati Sthapati, B.A., F.I.I.A.

Chennai, India

Most Respected Madam Jessie,

I am really happy that you have thrown your heart and soul into the revised presentation of the thesis on "Fabric of the Universe"

As you say some new items have been included, so that the scholars acquainted with sin waves, which appears to be appropriate in the context you have introduced. I thank you for introducing a very apt term for flexion of the spirit when we do certain work concerning sculpture and perform dance. The illustrations would prove apt to see and understand.

As regards to the other new items and discussions, I am really proud of you my dear madam, who having got associated with our research work and our Vaastu Vedic Research Foundation from the near past.

Though readers will be new to the subject, they will be able to internalize and comprehend the sacred material.

With Regards,
Yours ever,

Dr. V. Ganapati Sthapati
April 29, 2006
Vaastu Vedic Research Foundation and
International Institute of Mayonic Science and Technology



INDEX

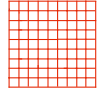

Chapter and Sections	Page
Forward	
Preface	
Chapter 1	
Fabric of The Universe: The Origins, Implications, and Applications of Vastu Science	
1. Introduction	1
2. What is Vastu Science	2
3. A lost science	3
4. The progenitor of Vastu	4
5. The Pranava Veda and Other Works by Mayan	8
Chapter 2	
The Manifestation Process Called Vastureva Vaastu: The Absolute Theory of Manifestation	
1. Manifestation Process	13
2. The Absolute Theory of Manifestation	15
3. The growth dynamics of the unmanifest	24
Chapter 3	26
Eight Equals Nine: The Relative Theory of Manifestation	
Chapter 4	34
What is Vaastu Science?	
Chapter 5	36
The Application of Vaastu Science	
Appendix A	48
Manifestation and The Square Wave: What the blip is going on?	
Appendix B	51
The Mayonic Code: The Physics of Wave Forms and Vastureva Vaastu	
Appendix C	60
More On The Formation of Square Waves and Sine Waves	

Preface

How does unmanifest, potential energy become manifest, material form?
 How do the buildings we live and work in influence our emotional & physical health and spiritual & material prosperity?

The fundamental crux of Vastu Science and Vaastu Science and Technology (the reason for the difference in spelling will become clear) is that Mayan, an ancient architect and Rishi perceived that there is one force, one fundamental First Principle from which all life emerges, and in which all life resides and ultimately returns to its Primal state of pure energy. He named this principle Brahman. He saw that Brahman, (Absolute Space, Consciousness, Potential Energy) by its own initiative, goes through a specific process to transform and manifest itself as the material world and its objects, Kinetic Energy. Mayan perceived that that process was accomplished through a mathematical order and that that order could be replicated by humans to unfold specific qualities of Brahman that would vibrate in a form that brought health, happiness and spiritual bliss to those who partook in that form. That form could be dance, poetry, music, sculpture, or architecture.

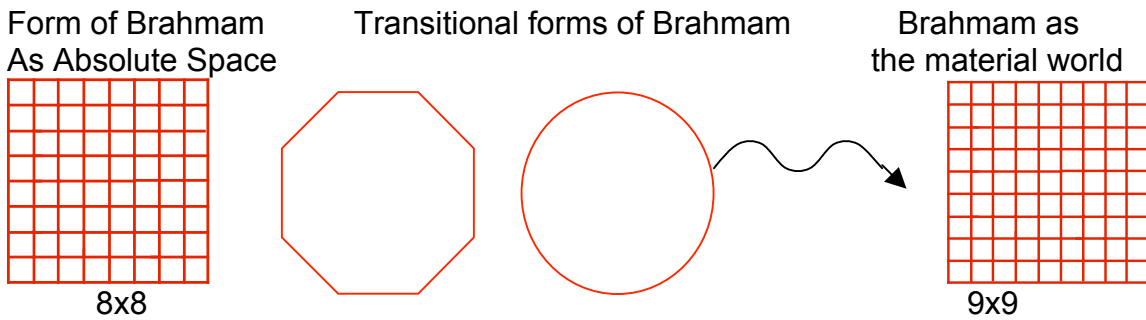

Unmanifest Absolute Space- Consciousness-Brahman transforms itself into manifest Consciousness- Brahman in forms such as trees, rocks, people etc.

Science ~ Religion

Tamas Guna - Rudra

Rajas Guna - Vishnu

Sattwa Guna - Brahma

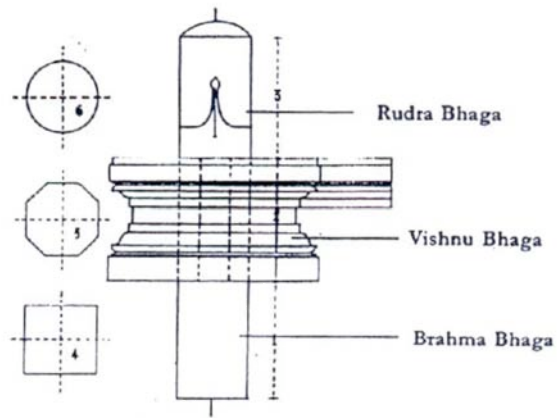

These three “gunas” or qualities are examples of the intermediary forms of Brahman as it transforms itself from unmanifest to manifest. They are both

forms and frequencies aroused within consciousness as it moves within itself to contain itself in material form. (These forms of Brahmam or First Principle are discussed in depth in *The Science of Mamuni Mayan's Vaastu Temple Architecture: Savoring Your Own Beauty*, by Dr. Jessie Mercay)

The universal laws of authentic Vaastu Shastra (Mayonic Science) reveal, in profound detail, how to create built space using the precise mathematical formulas, inherent in all creative activities, which take place in nature. A Vaastu structure is a vibrant, self-contained living organism, which serves to enhance all positive qualities of life for its inhabitants.

This book is not a technical manual on building architecture. However, it will provide an in - depth analysis of the autocatalytic dynamic process of Vastureva Vaastu and its application to modern residential and business building architecture. Yet, the study of this body of knowledge is vital for anyone wishing to engage in the building architecture of Sthapatya Veda/ Vaastu architecture.

Brahmarishi Mayan said very succinctly in his Aintiram: "Through the power of inner consciousness, the knower of Vastu should know about light aspects and sound aspects of OM pertaining to both inner and outer space. Those who do not realize the creative dynamism of inner space cannot know the dynamism of outer space." (195,831)

In this text, there will be strange and new terms that you will apprehend as well as mind and consciousness expanding concepts. Through many readings and deep study, if you choose this path of Mayonic Science and Technology, you will ultimately learn that health, well being and spiritual bliss can be found right at your own doorstep.



Fabric of The Universe: The Origins, Implications, and Applications of Vastu Science

ॐ ॐ

“The spiritual culture of the land of India owes its origin to the traditional Indian science of Vaastu Shastra found abundantly reflected in the architectural and sculptural expressions of temples, forts, palaces, town and city layout of ancient India. Today it is re-emerging spectacularly and the benefits of this spiritual science are availed throughout the world, by its application in the design and construction of public, residential and religious buildings. This science deals with the eternal process of the subtle energy manifesting into material space or material form. In short, it is the science of manifestation of energy into matter or material form.” (Dr. V. Ganapati Sthapati, www.vastuved.com)

1.

Introduction

Vastu is a term that is enjoying world - wide notoriety; however there are many misconceptions and distortions about authentic Vastu. It is erroneously thought of as a kind of East Indian Feng Shui. Well-meaning Vastu consultants are attempting to help improve living spaces by moving furniture and by use of yantras, mandalas, crystals, mirrors and any number of so-called Vastu correction devices. In some cases furniture is moved and people are told to place what is called the “Vastu Purusha Mandala” on their wall and they will feel much better in their home. While they may be attractive and aesthetically pleasing, none of these “remedies” are in fact legitimate corrections for “faulty” Vastu. The fact is, the all too frequent misuse of the word “Vastu” is indicative of a fundamental lack of understanding of the authentic science.

Authentic Vastu, as presented by Dr. V. Ganapati Sthapati – the preeminent world figure in Vastu Science, is a highly complex science that requires thoughtful study and precise execution. It is a science born of knowledge of physics, mathematics and astronomy. It involves comprehension of Space, Time, Light, Sound, and the five elements, and an understanding of the dynamics of manifestation of energy from potential energy (Primal) to kinetic energy (matter or form). Finally, it requires the ability to apply this scientific knowledge to architecture, sculpture, poetry, dance, and music. Despite these facts, anyone willing to put in a little bit of effort can understand the basics of Vastu.

This book will define Vastu Science and trace its origins and history. Rather than being a technical manual, it will reveal and illuminate the mechanics of creation from intangible Absolute Space through the weaving of the fabric of creation to the emergence of the material world.

What is Vastu Science?

The term Vastu refers to primal, unmanifest, potential energy. It is the energy through which all material forms manifest. Throughout history and among many cultures, this primal energy has been given many names. The names range from religious (God, Brahman) to scientific (the Quantum Field). Vastu is that unmanifest energy that lives eternally.

An examination of the various Sanskrit and Tamil meanings associated with the root “vas” and the combined word “vastu” and “vaastu” will shed light on the comprehension of the meaning of Vastu Science.

Vas: to shine; to grow bright, to bestow by shining upon, to cause to shine; to enter into, to dwell, becoming light, dawning, the seat or place of, an abiding substance or essence, the pith or substance of something, to cohabit with.

Vaas: to make fragrant or to perfume, an intoxicant, to be or make firm, dwelling place, to assume the appearance of, matter. (Cologne Lexicon)

“The word “vastu” is formed of the root “vas. “ “Vas” means to live or to exist. The precise meaning of “vastu” is “to live eternally.” (Dr. V. Ganapati, Sthapati, p.52 Temples of Space-Science, Vaastu Vedic Research Foundation, 1996). Thus, Vastu is that energy of force that lives eternally. It is never ending and omnipresent.

In examining these definitions, we can see that *Vastu* is the seat of an abiding, shining substance or essence. It has a quality of growing brightness and is the pith or substance that enters into and cohabits with that in which it dwells. It is the source of all of the material world yet it cohabits with the material world as *Vaastu*. It does not separate itself from the material world.

Vaastu is that which assumes the appearance of matter. It makes firm or gives concrete shape to the place where it dwells. It makes fragrant that in which it dwells. That fragrance is the intoxicating spiritual bliss experienced by people who live in or visit a *Vaastu* structure.

Vastu Science is an ancient science that describes the process through which *Vastu* (unmanifest) turns itself into *Vaastu* (manifest forms and material). *Vastu* written with one “a” refers to unmanifest Absolute Space or Pure Consciousness. *Vastu* written with two “a’s” (*Vaastu*) refers to the unmanifest Absolute Space having taken on its material form. Vastu Science then is the science of

unmanifest Pure Consciousness and Vaastu Science is the science of manifest Pure Consciousness (Vastu as the material world).

Vastu Science gives rise to Vaastu technology. That is, an understanding of Vastu Science provides the basis for understanding the use of Vaastu technology in the relative material world. Vaastu Technology arises from Vastu Science. One must understand Vastu Science before one can understand and execute Vaastu technology properly.

“This science deals with the eternal process of the subtle energy manifesting into material space or material form. In short, it is the science of manifestation of energy into matter or material form.” (Dr. V. Ganapati Sthapati).

In understanding the meaning of this we must first gain a perspective on the history and science of Vastu as it relates to its origin and processes.

There are many permutations of “Vastu” as being practiced today. Throughout the world many individuals have undertaken the study and practice of “Vastu” through the use of incomplete books and teachings. Unfortunately modern Vastu has been diminished to the level of superstition. An authentic practitioner is a Vaastu practitioner and not a Vastu practitioner. What is practiced and applied in the material world is Vaastu not Vastu. The authentic Vaastu consultant does not use yantras, crystals, incense, mirrors, or any other devices to allegedly correct deficiencies in a home or office. While being completely sincere, most practitioners simply don’t know Vastu or Vaastu in their purity nor are they aware of the very simple aspects that render Vastu and Vaastu the most powerful sciences in the entire world. These two sciences are far more than mere smoke and mirrors.

In November 2003, the president of India, DR. A.P. J. Abdul Kalam became aware that the media and society in general had polluted the term “Vaastu.” He also became aware that ultimately this pollution would be harmful to society and individuals. He asked Dr. V. Ganapati Sthapati, the renowned architect, scientist and artist to change the name of Vaastu. Dr. Sthapati replied by saying that he would change the understanding. He did in fact change the name to Mayonic Science and Technology although he still refers to the terms Vastu and Vaastu in their correct context. To this day he works tirelessly to educate the world about the truth of this great science. He even began a University in the Americas (www.aumscience.com) to carry out his task of bring the truth to light.

A lost science

Authentic Vastu has been a lost science for centuries because the detailed scientific texts (which include knowledge of quantum physics, astrophysics, astronomy, nuclear physics, and mathematics), written in technical terms, were not understood by scribes and scholars over the past centuries. Technical language contained in the original texts were unknown to the translators hence,

the crucial scientific and mathematical aspects of Vastu were left out of the Vedic texts. Without the scientific and mathematical technologies contained in the original texts, and the practical applications used by the Shilpis, all that remained was superstition and partial truth. It is through the efforts of Dr. V. Ganapati Sthapati, the eminent architect, sculptor and teacher, that the ancient science and art of Vastu is being revived in its completeness.

Dr. V. Ganapati Sthapati is the former president of the Government College of Architecture and Sculpture in Mamallapuram, India .He comes from a lineage of over 1000 years of Architect/sculptors. Because of his background and expertise, the government invited Dr. Sthapati to examine palm leaf texts that had been discovered in a 10,000-year-old library in South India. Being a member of the ancient Shilpi clan, the clan that has faithfully maintained the purity of the knowledge of Vastu/Vaastu, Dr. Sthapati had the expertise that was missing from the qualifications of previous translators – he understood the technical and scientific terms within the ancient texts. He has since translated and studied thousands of these recently discovered texts that contain the knowledge of the author of original Vastu. With the knowledge gained from this and what he learned through over one hundred generations of family experience in Vastu Science, Dr. Sthapati was able to revive age-old authentic Vastu. This brought new knowledge and accuracy to the present day art and science of Vastu and Vaastu.



Photo by M.Borden



Mamuni Mayan

The Progenitor of Vastu

A great scientist/ artist named Mamuni Mayan (between 10,000 and 13,500 years ago) originated this ancient work, Vastu Science and Vaastu Science and Technology. Mayan lived on a landmass south of India, south of the present Kanyakumari, known as Kumari Continent. This landmass was called Kumari Mandalam during Sangam days (a period of time in ancient history when scientists and scholars met and shared their ideas, literature, music, art, and scientific discoveries) and today it is known as the Lumerian Continent. This is thought to be the original home of the human race and human culture according to ancient texts.

Due to a series of land disturbances, including ocean water encroachments from melting icecaps and deluges, the continent became a series of islands and other landmasses separated by the ocean. One large island called Jamboo Dweepa was the home of Mamuni Mayan. Just before the last great deluge (perhaps the Biblical flood of Noah) that covered Jamboo Dweepa with water Mayan migrated to Southern India. During that time, he established Vastu and Vaastu as a dynamic science and technology. His work covered numerous areas including architecture, sculpture, dance, music and other art forms, astronomy and astrology, and herbology. To give credit to the progenitor, Mayan, and to differentiate this science from incomplete forms of Vastu that predominate in this and recent centuries, we call this entire field of study Mayonic Science.

At one point in history, many cultures based their architecture, art, herbology, astronomy/astrology, etc. on Mayonic Science. In addition to the East Indian culture, cultures of China, Tibet, Mexico and Central and Southern Americas used Mayonic Science and Technology as the basis of their culture. We see evidence of this in the precise mathematical Vaastu formulas evident in the many Mayan structures existing today in Mexico and Central America, China, Bosnia, Egypt, Japan, and in other parts of the world. The Aztec ruins in Mexico and

the Incan ruins in Machu Picchu, Peru also demonstrate Mayonic measure and order. Recent discoveries in Peru have identified what appears to be pre Incan Mayonic structures.

One of those cultures even adopted the name Mayan – the Mayan culture of Mexico and Central America. The name Mayan is derived from Tamil – the language of South India and the language in which the original Vastu/Vaastu texts are written.

Mayan was an individual who had the depth and clarity of perception to understand the physics of manifestation of Pure Consciousness (Absolute Space) from its unmanifest state (Vastu) to its manifest state (Vaastu).

Through precise mathematical formulas Mayan was able to recreate the process of pure consciousness (Absolute Space) becoming conscious and awakened in structures such as buildings, temples, statues, dance, music and other forms of expression. These structures created in this way became “live” or living structures. One might say that through the knowledge of “consciousness becoming conscious,” life was breathed into forms and structures.

In addition, through precise mathematical formulas, Mayan was able to create structures that were not only alive with pure consciousness but also resonated specifically to the individual resonance of any given human being. Thus, the human being had direct and immediate contact/resonance with Pure Consciousness making the individual more alive and vibrant “just as life is within the space boundaries of our flesh and skin” (oral commentary by Dr. V. Ganapati Sthapati).

Dr V. Ganapati Sthapati writes:

“Mayan the architect and town planner of India and the progenitor of Vaastu Shastra lived in the southern part of the Indian sub-continent, known as Kumari Mandalam (Lumerian Continent), some ten to fifteen thousand years ago. He is the author of Mayamata Vastu Shastra and Surya Siddhanta, the two great works, which are still alive, being used by scholars and practitioners, all over India. They have revolutionized the erstwhile material culture of India into a spiritual one and today they are known worldwide and admired for the rich scientific material, they contain.

References about him are found in our epics Ramayanam and Mahabharatam. In Mahabharatam, he is found to have been introduced by Veda Vyasa to Arjuna as Viswakarma - "ahamhi Viswakarma vai dana vanam mahakavi" – I am the Viswakarma (the creator) and the great poet of the Danava clan. It shows that he was adored as the poet of Danavas and as Viswakarma, implying thereby that Mayan was aware of the dynamics of the

Space and was able to apply the space-mechanism in his own creations and transform them to little universes on earth. Whatever be the creation, a building, a sculpture, a town or a city, they behaved like living organisms pulsating with life. Hence he was rightly called Viswakarma of the material world or sometimes as the Viswakarama of the celestial world. No scientist of his caliber or status is found to have emerged in the soil of Bharat to date.

In Ramayana, Maharishi Valmiki extols him as highly enlightened and endowed with super human intelligence and talents. In the words of Sage Valmiki, Mayan was 'mahatejaswi' and 'maayaavi'. 'mayonaama mahaateja maayaavi vaanarishabha.'

Another authority that introduces Mayan to the later day shilpins is Prince Elango of Kerala, in his historical epic 'Silappathikaaram', as a tradition builder. He has also authored the most ancient and scientific treatise on Astronomy titled 'Surya Sidhanta'. As scholars have pointed out it is he who has painted a comprehensive but succinct picture of Brahman, the Ultimate and Absolute, addressed as Kaala Brahman by Mayan himself. This particular identification of Time as Brahman has earned him a significant title 'Kaalajnani' (one who has recognized that Time is the causal element of the universe and universal objects – visual and aural forms). It is he who has equated Time and Space and evolved a system of spiritual arts namely poetry, music, dance, architecture and sculpture – all governed by the principle of energy vibrating into space and spatial form.

There is another treatise carrying his name, called Mayamatam, where we have the principles of Vastu and Vaastu, rendered in the pattern of a technological treatise, followed by the shilpis across the length and breadth of India.

Another notable discovery made recently is that he was the author of Pranava Veda, the primal and most significant of all Vedas, which is referred in Bhagavata Mahapurana as 'eka eva pura vedah pranavo sarva vangmayah', whereby, Veda Vyasa confirms the existence of the one and only Veda in the very remote past. Today it is found to have been originated in the Kumari Continent, Mayan being the author. The text in technical Tamil, as the Siddha literature of the Tamils, is getting printed and likely to see the light of day before long.

There is already a Tamil text of Mayan called AINTIRAM, published by the Directorate of Technical Education, Govt. of Tamil Nadu,

India. It is actually another version of Pranava Veda in sutra form. Later day scholars called this Aintira Vyakarana. This appears to have served as a 'source book' for later day grammar of Indian languages." (www.Vastuved.com)

Among his great achievements, Mayan identified the structure of infinite and finite energy particles. Mayan defined the vibration of inner Space and outer space as a quantifiable, and was able to identify the structure of energy particles and an order in the development of forms of matter. He described Absolute Time and used mathematics to define frequency and vibration.



Brahmarishi Mayan

अचिन्त्य अव्यक्त रूपाय निर्गुणाय गुणात्मने ।
समस्त जगदाधार मूर्तये ब्रह्मणेनमः ॥ -मयः

பரம்பொருள் எங்கும் உண்டு பெருங்கலை யாண்டும் உண்டு
பரம்பொருள் உணர்வினாலே ஒளி வழிபாடு கண்டேன்
பரம்பொருள் அருளினாலே திருநடராசன் கண்டேன்
பரம்பொருள் அருளினாலே மாக்கலை படைத்தேன் காண்பீர்

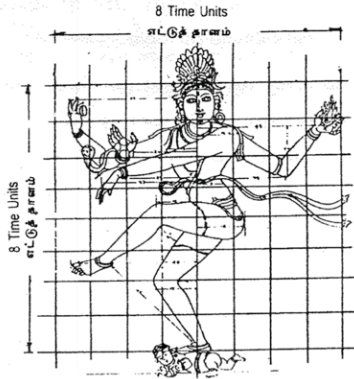

**VAASTU PURUSHA MANDALA
ENERGY - GRID**

"Absolute Time creates life"

"Mathematics has its roots in Time"

"The vibrating element called 'Time' causes this phenomenon"

From Building Architecture of Sthapatya Veda by Dr. V. Ganapati Sthapati

In this mandala Shiva represents the scientific principle of vibrating pure energy and depicts frequency in the Absolute Space/Time continuum. This will be discussed in more detail later.

MAYAN, states that:

"There exists an order in the Universe - subtle universe, and material universe. This power is attributed to the consciousness of the cosmic space as well as of the inner space of the animate beings. This consciousness, by its personal effort to express its own inner feelings, causes a kind of vibration or pulsation in the inner space, resulting in energy-grids. The vibration or pulsation, being the causal element of all these events, is called KAALA. This is actually the force of energy aroused by the inner consciousness, causing waves and contributing to the growth of living forms. This KAALA resides in all living beings. So, space is the offshoot of the vibration of the primordial energy. This is how the space was born. All forms of nature are manifest forms of subtle energy. For all to get manifested, the force is KAALAM. This wave-form frequency realm is the creative element of the universe." (Aintiram)

Mayan took these fundamental principles and applied them to all manifestations of consciousness. Thus, the force of Kaalam (Absolute Time, pulse, frequency) was seen to influence the entire cosmos. Mayan articulated these and other principles in a number of texts including the one million verses of the Pranava Veda.

The Pranava Veda and Other Works by Mayan

As mentioned earlier, the Pranava Veda is the first Veda and the “source Veda.” Dr. V. Ganapati Sthapati explains, “A good deal of evidences is available both in Tamil as well as in Sanskrit works, particularly in Srimat Bhagavatam and Skandam about the remote existence of Pranava Veda. This Veda was later on called the science of Vastu (energy) and Vaastu (embodied energy), which is gaining much popularity today across the globe.”

Dr. V. Ganapati Sthapati goes on to say that Veda Vyasa himself said in the Bhagavatam:

“eka eva pura vedo pranavha sarva vangmayha”
(9th skandha, 14th chapter, sloka 48 of Bhagavatam)

This phrase by Veda Vyasa, the compiler of the present day Vedas, means that there was only one Veda in the remote past and that Veda is called Pranava Veda - the Veda of the shilpis of India. Artharva Sheershopanishad makes mention of the term “Pranava” as being “ongara” – the all-pervasive substance.

Pranava Veda elucidates the science of Pranava. It is the scientific study of The All Pervading Substance. Pranava Veda presents the science of “how the invisible substance of the universe (paravastu) makes itself manifest in the visible material (Vaastu) forms.” In other words, Pranava Veda reveals the process of how the All Pervasive pure Energy turns into Matter or material existence.

(www.vastuved.com)

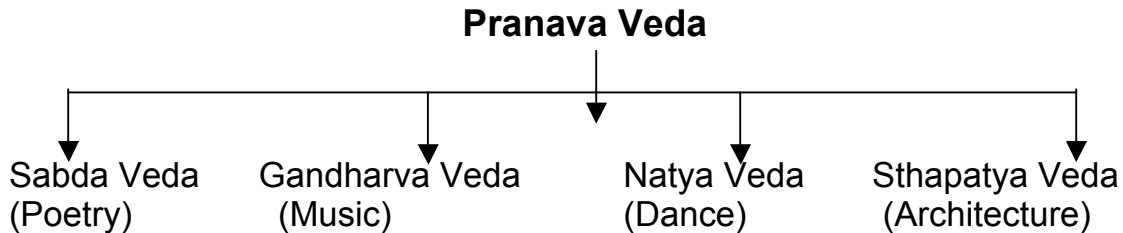

What we see above is called the “Five fold Veda.” This is the “source” Veda that presents the scientific manifestation process (Pranava Veda) and the four products of that manifestation (poetry, music, dance, and architecture).

All of these “forms” (poetry, music, dance, architecture) are generated from the Unmanifest Space or Brahmam based on SPACE, TIME, SOUND and LIGHT which give rise to all aural and visual forms in the manifest world. In this science and technology, each of these manifest forms of paravastu or Vastu are governed by a common grammar of Kaala mana (time units) called Taala maana. The dominant and all pervasive element in the creation of these forms is the concept and process of the unmanifest becoming manifest by its own creative nature.

Based upon this theory of manifestation, and to signify the Five Fold Veda, the Shilpis have created a form with five heads. This form is called Vishwakarma. It represents the five Vedas, that is the Pranava Veda which is the instruction manual for how the Unmanifest (Vastu) turns Itself into Manifest creation (Vaastu) and the four products of that manifestation (poetry, music, dance and architecture/)

The Surya Siddhanta

The most ancient treatise on Astronomy is a treatise authored by Mayan. It is called *The Surya Siddhanta*. Included in this treatise are the following chapter topics following the Introduction:

- I. The Motions of the Planets
- II. The Places of the Planets
- III. Direction, Place and Time
- IV. The Moon and Eclipses
- V. The Sun and Eclipses
- VI. The Projection of Eclipses
- VII. Planetary Conjunctions
- VIII. Of the Stars
- IX. Risings and Settings
- X. The Moon's Risings and Settings
- XI. Certain Malignant Aspects of the Sun and Moon
- XII. Cosmogony, Geography, and Dimensions of the Creation
- XIII. The Gnomon
- XIV. The Movement of the Heavens and Human Activity

Mayan is the author and Mayan's name occurs in the text itself as Mayasura. Scholars have ignored his authorship and profound scholarship and attributed it to a later day astronomer. Mayan was dismissed as an asura with the definition of asura misrepresented as meaning demon. Unknown to those scholars and present day scholars, the term "asura" means one who is spiritually and intellectually strong and supreme in ability above others. In actuality, the great Vedic Gods Indra and Varuna are classified as asuras. (Dr. V.G. Sthapati, p. 79, Building Architecture of Stapatya Ved, Second edition, September 2005)

Medical Treatise on the Siddha System

We know from ancient texts that Mayan wrote *Treatise on Herbology*. This is the oldest known codified reference on the topic. Dr. S.P Sabharathnam, secretary, International Society for Investigation of Ancient Civilization, Chennai, India who is a longtime researcher of Siddha literature, refers to Mayan as a Siddha – a self realized person of great spiritual power and ability. Given this and his interest in herbology, it is not surprising that Mayan most likely is the author of the medical treatises on the Siddha System of Medicine often thought to be the precursor to Ayurvedic Medicine.

Technical works

The following are technical works written by Mayan and represent the 12 vowels of the Tamil language:

- | | |
|----------------------|--|
| 1. Ovia Chenool | Treatise on Drafting and Painting |
| 2. Sirpama Chenool | Treatise on Iconometry |
| 3. Kattida Chenool | Treatise on Architecture |
| 4. Nilamanai Chenool | Treatise on House Building based on quality of land |
| 5. Manainila Chenool | Treatise on Land based on the nature of house building |
| 6. Baniyal Chenool | Treatise on Astro Physics |
| 7. Perunata Chenool | Treatise on Divine dance |
| 8. Muligai Chenool | Treatise on Herbs |
| 9. Ganitama Chenool | Treatise on Mathematics |
| 10. Arakkala Chenool | Treatise on Ship Building |
| 11. Vinkala Chenool | Treatise on Space Ship |
| 12. Elisai Chenool | Treatise on Science of Music |

It is quite interesting to note that the Treatise on Drafting and Painting and the Treatise on Iconometry exist in Sanskrit texts, but they are mutilated and mistranslated and are unintelligible when read. Those aspects of Vastu Science (the science of Energy, Matter, Time and Space, and Space and Spatial Forms) missing from the Sanskrit texts exist in their entirety and completeness in the Tamil Vaastu Shilpa texts and in Mayan's Aintiram in sutra form. The Aintiram is held as the Brahma Sutra of the science of visual and aural forms. This term, Brahma sutra, is a technical and scientific term originating in Aintiram and now found in the Vaastu Shastra today. (Dr. V. G. Sthapati, Building Architecture of Stapatya Ved, Second edition, September 2005)

The Aintiram

In Mayan's deep, spiritual and scientific Treatise called the Aintiram, the profound underpinnings of Vastu Science are articulated. From the text itself, it is clear that this Treatise was written for and presented to a meeting of scholars called in those times a Sangam. In the text Mayan mentions his own name thus there is little reason to doubt that he wrote it.

The following is a summary of some of the principles put forth by Mayan in the Aintiram:

1. All objects of nature are unified entities (forms) of energy and matter.
2. The free space is the unified field of energy and matter and source of all forms that we see in material world.
3. There are two OMs: OM Light and OM Sound, the former is the source of all visible objects and the latter, the source of all aural forms.
4. All material forms of the universe are musical forms or have taken shape on musical rhythm or musical scale.

5. Time creates, sustains, and destroys all, so created.
6. The primal manifest form of the unmanifest is square (primal wave pattern).
7. The primal square pattern is designated as the diagram of embodied energy – Vaastu Purusha mandala.
8. The free space is packed with cubical atoms of energy. They are building blocks of the structure of the universe.
9. The cube is micro-abode called Sittravai/Chittrambalam (mini hall in Tamil).
10. Within the hall there is a vertical luminous shaft called Brahma Sutra (Olinool).
11. This Olinool/Brahma Sutra is a shaft of consciousness also called Moolathoon/Moolasthambham.
12. This shaft of consciousness vibrates in a particular order called rhythm. This is the order of nature.
13. This rhythmic vibration of the shaft of consciousness is the dance of Shiva, the Space.
14. The micro space, in the cubical shape is foetus, Garbha or Bindu. This is known as Vinkaru in Tamil.
15. This micro abode is the repository of light and sound.
16. The free space is Light and the Light is Moolam or source of the universe and universal forms. Light is Brahman, Atman, Vastu Brahman – Nunporul in Tamil.
17. The embodied energy is Vaastu Brahman/Vaastu Purushan. The space enclosed in a building is Prasada Purushan – energized building – Building is a living organism, built of musical units of measure.
18. Architecture is the supreme achievement of mathematics.
19. Mathematics is rooted in the dynamism of Absolute Time.
20. Time is the vibration of Space.
21. Time and Space are equal.
22. Time is one of the subtle elements of Space (akasa).
23. Time is the causal element of all objects of the Universe.
24. The microcosmic structure is in total identity with macrocosmic structure.
25. The supreme space is throbbing every moment to express itself out.
26. Through the power of inner consciousness, the knower of Vastu should know about light aspects and sound aspects of OM pertaining to both inner and outer space.
27. Those who do not realize the creative dynamism of inner space cannot know the dynamism of outer space (195,831).

While these ideas may seem unfamiliar or perhaps abstract, their meaning and significance becomes clear as one delves more deeply into the science of Vastureva Vaastu- energy becoming matter through the manifestation process.

2. The Manifestation Process Called Vastureva Vaastu: The Absolute Theory of Manifestation

“The Self unfolds Itself, by Itself, for its Self”
Bhagavad Gita

The crux of Vastu Science and Technology is the manifestation process called Vastureva Vaastu and the application of those principles to poetry, dance, music and architecture. While our focus in this document is on built space in the form of architecture, the same principles apply in terms of the manifestation process regarding sculpture, music, poetry and dance.

Vastureva Vaastu simply means unmanifest pure potential Energy (Vastu) turning itself into material form (Vaastu). This is the technical meaning of the term Pranava. With the understanding of this process and the simultaneous yet successive manner in which it occurs, one comes to fully realize that Vastu *is* Vaastu. Pure Consciousness, Brahman, is the same as the material world and the material world is the same as Pure Consciousness, Brahman. There really is no distinction between manifest and unmanifest. There is no distinction between an individual and consciousness itself.

Patanjali, in his yoga sutras, recommends that a seeker perform dharna (concentration), dhyana (contemplation), and samadhi (deep meditation) on the distinction between buddhi (representing manifest) and purusha (representing unmanifest) and he or she will experience an awakening. That awakening comes because eventually over time one realizes that, as pointed out by Mayan, there is no distinction between Budhi and Purusha. They are one and the same. Everything in the manifest world is nothing but consciousness. When that awareness becomes a permanent experience then the goal of life is realized. The study and application of Vastu Science is a path to that realization because understanding and experiencing Vastureva Vaastu on a very deep level promotes the understanding and experience that All is One.

“... forms produced by the application of Vaastu Science are the forms of the Spirit...”

Dr. V. Ganapati Sthapati

The following diagram, created by Dr. V. Ganapati Sthapati, depicts the process of Vastu becoming Vaastu- potential energy transforming into kinetic energy. While at first the process may seem complicated, as you read on you will find that it is in actuality simple and elegant. As you read, know that this process is occurring every nano second within your own Self. Read with an open heart and open mind. That openness will create deep and profound understanding that you will find to be transformative.

* अचिन्त्य अव्यक्तरूपाय निर्गुणाय गुणात्मने ।
समस्त जगदाधार मूर्तये ब्रह्मणेनमः ॥

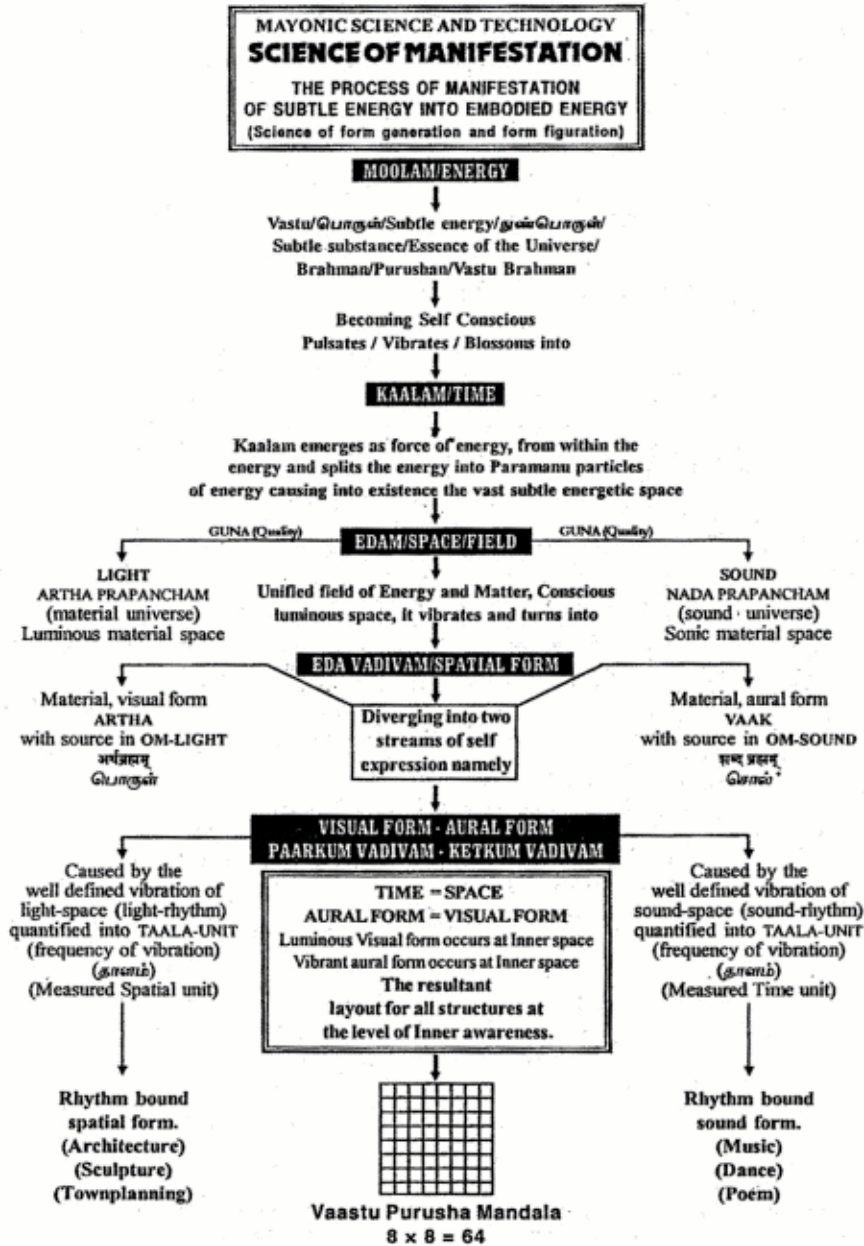

TRI-Dimensionally every particle of space
is a subtle cube of energy, called CHITRAMBALAM or MICRO-ABODE
within which there is a 'shaft of light' or  'shaft of consciousness' vibrating or
performing a 'rhythmic dance'. This is the dance of the DANCER, GOD SHIVA.

The whole universe is filled with subtle cubes of energy called KARU or BINDU or FOETUS.

* Brahman as defined by Mayan, in his astronomical treatise called 'Surya Siddhanta'.

The Absolute Theory of Manifestation

“Though I am unborn and of imperishable nature, though Lord of all beings, yet remaining in My own nature I take birth through My own power of creation.”

(Bhagavad-Gita Ch 4. v6)

Imagine a vast, unbounded field of pure, unmoving potential energy. This field has no beginning and no end. It just is. This is the field called Absolute Space. It can be represented here for the sake of analogy as a flat line.



This Absolute space can be called Zero Point or Zero Time, no time, Absolute stillness and silence.

Now imagine that flat unbounded Absolute Space beginning to move within itself or pulse within itself. Using the flat line, we will create a pulse in that line.

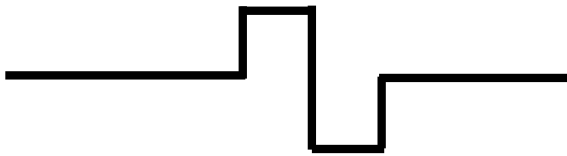

The act of pulsing created an element called Absolute Time.

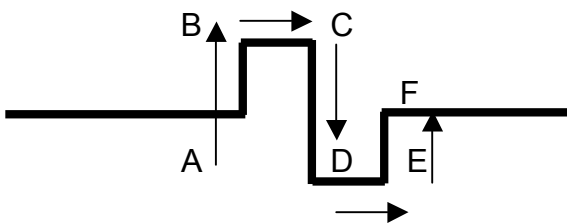

What do we mean by Absolute Time? From the moment that Absolute Space began to pulse (point A) it went through a *time* sequence. That is, it took “*time*” to move from point A to point B; from point B to Point C; from point C to point D; from point D to point E and point E to point F. The pulse rises and then falls back to the steady state – represented as the fat line.



It is said by Mayan in The Aintiram “Time creates.” sustains, and destroys all, so created.” It is easy to see that it is indeed “Time” that created and destroyed the form or pulse in Absolute Space.

At this point in the genesis of space becoming matter, we have two elements present: Absolute Space and Absolute Time. These two elements form a micro cube. As these two elements continue and co-mingle, a clockwise self spin occurs as time marches on from point A to B to C to D to A.

Representation of this Self spin is noted throughout history in many cultures including China, Tibet, Nepal, Mexico, Native American, South Pacific and of course India. The images or a permutation of the image is in the form of the swastika. This image is not to be confused with the tilted swastika used by the Nazis.

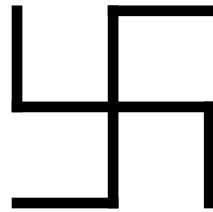

As the co mingling of the elements of 1. Absolute Space and 2. Absolute Time continues, a third element 3. OM light is produced. Then, with the co mingling of 1. Absolute Space + 2. Absolute Time + 3. Om Light a fourth element is produced called OM Sound. Right here at this very moment you can see that OM Sound is a well-known element mentioned profusely in Vedic texts but OM Light has been left out of the Vedas. OM Light eventually gives rise to all visual forms and OM Sound eventually gives rise to all oral forms (language etc).

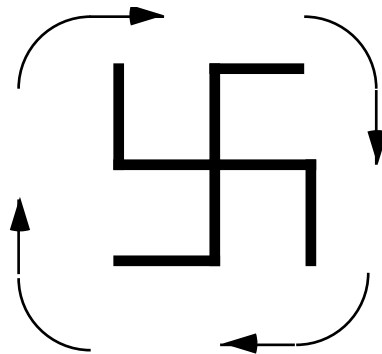

As this unmanifest structure continues to spin around the central point called the Bindu Point (micro cube), and with the co mingling of the four elements the cubicle shape gains more structure and mass.

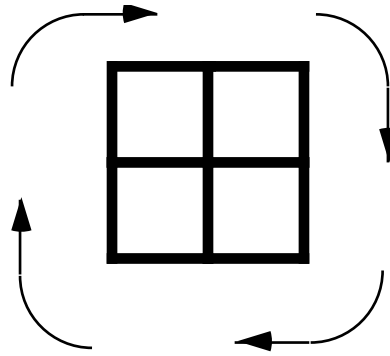

With the continued self-spin and additive, commingling effect of 1. Absolute Space + 2. Absolute Time + 3. Om Light + 4. OM Sound we see the formulation of yet another element called Air. This is still in pre - manifest crystalline structure. The qualities of the element are not yet the gross qualities that can be perceived in the manifest world.

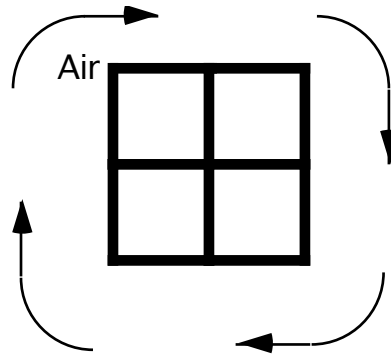

Note the position of the formation of the air element within the cubicle structure. It is as if the centrifugal force of the self - spin caused the previous elements to coalesce as the air element in that locality in the Time/Space continuum.

Self-spin continues, and with the addition of the Air element, the micro cube begins to take on more mass as 1. Absolute Space + 2. Absolute Time + 3. Om Light + 4. OM Sound 5. Air commingle and coalesce.

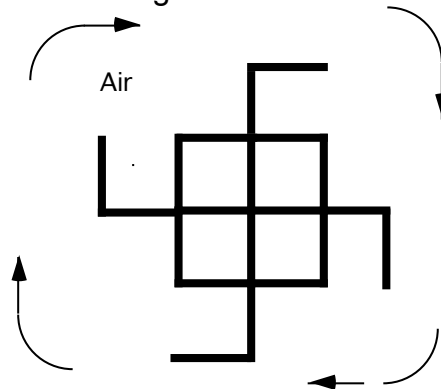

Through Time, that is, the Time it takes to spin a half turn, the commingling and coalescence of the existing elements form a new element. That element is Fire.

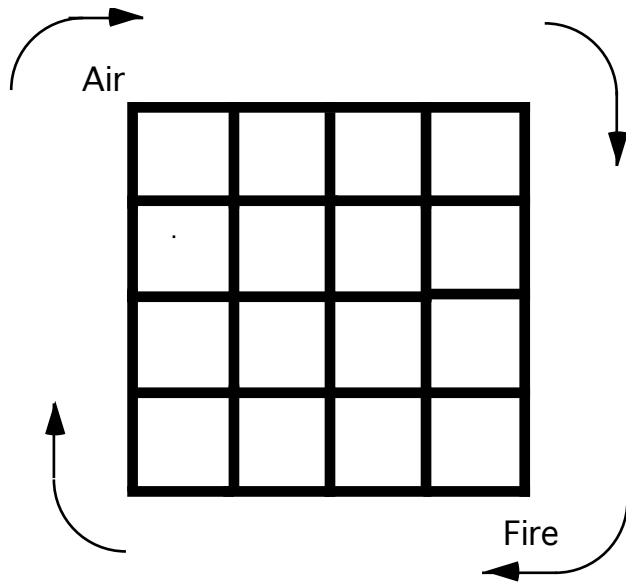

Notice that the elements form the Fire element in a specific quadrant just as the previous elements formed the air element in a specific quadrant. Why? It is due to Time. Absolute Time. "Time creates, sustains, and destroys all, so created." (Mayan, Aintiram)

As Self Spin continues, the elements with their new companion, Fire, continue to add to each other and coalesce again and again.

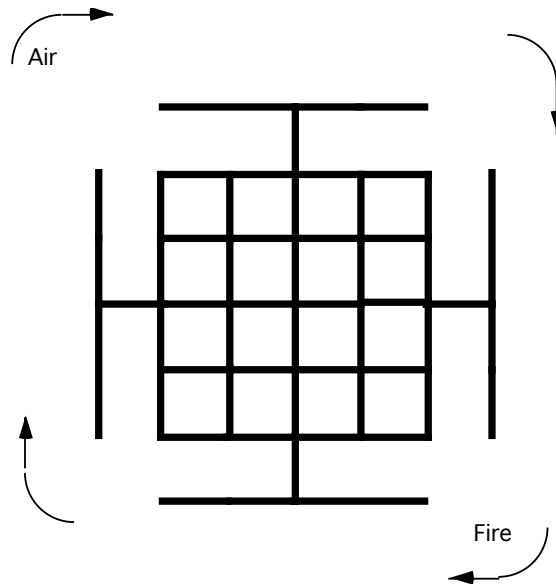

4x4 transforming to 6x6

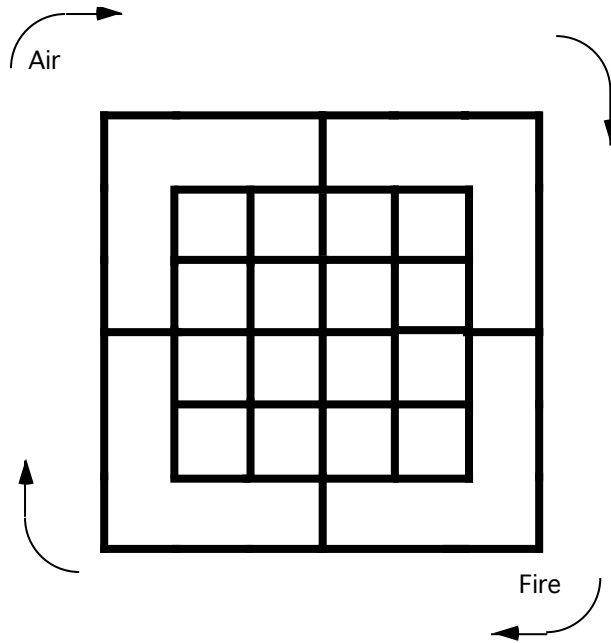

As the progression of the elements with Time as the leader continues, the commingling and coalescence create a new individualized element called water.

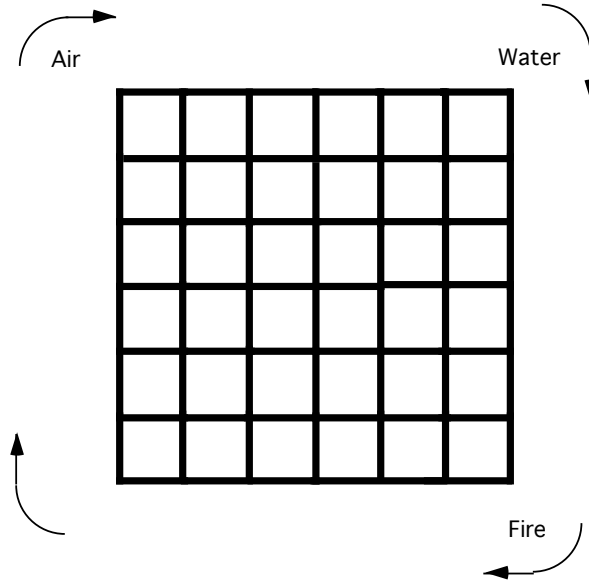

Once again in the progression continues with process of all of the previous elements adding together with each other and combining to form yet another element Earth. 1. Absolute Space + 2. Absolute Time + 3. Om Light + 4. OM Sound +5. Air 6. Fire +7. Water = 8. Earth. Creating Eight Absolute Elements in all.

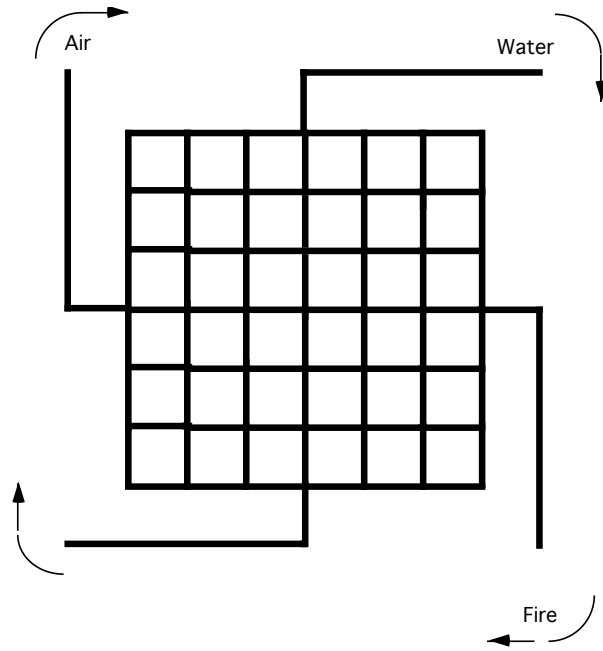

All of the aforementioned Elements continue to commingle and develop together in a natural order and frequency to form the Earth element and simultaneously the fully realized cube – Vastu Purusha Mandala called Manduka Mandala.

Fully formed 8x8 Manduka Mandala.

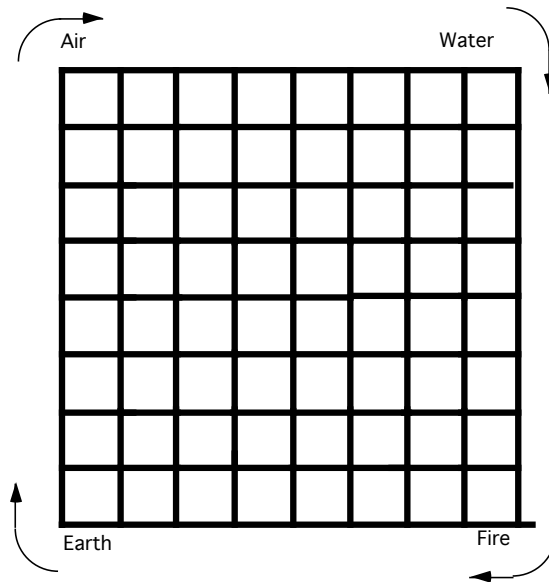

There are several important points to note here:

1. We now have an 8x8 cube. This 8x8 cube is called Manduka Mandala. Manduka means frog. The significance of this name of a leaping or jumping creature associated with this Mandala will become clear as you read on.
2. There are 64 modules or padas within the 8x8 cube. Each module/pada within the cube is of equal size and shape. Within each module or sub – cube, the process just described (formation of Time, OM light and OM Sound, Air, Fire, Water etc.) is occurring on a miniscule level and mirroring the original process that we are discussing.
3. As the original micro-cube continues to spin and expand through Space and Time, and as the elements of Air, Fire, and Water and Earth are formed, Space organizes itself in cubes that mirror the original micro cube. These cubes are strung together forming bands around the central point. Remember that the origin of the micro cube was a pulse in Absolute Space. This pulse caused the onset of Absolute Time. Pulses in Time linked together form rhythm; rhythm through space forms frequencies; frequencies form meter or beat; frequencies and meter/beat have a numerical equivalent; the numerical equivalent can be translated into specific qualities based upon the length of the beat and frequency just as the various lengths of strings on a musical instrument produce different qualities of sound when plucked.
4. The individual horizontal and vertical lines contain the potency of primal light and sound in the form of frequency.
5. The frequencies created by the cubes strung together form Space/ Time bands around the central module or “pada” that expand outward as each element is created. These are bands of energy or frequency that have particular attributes based upon the elements that predominate within these bands.
6. The cubical structure of the 64 squares of the Manduka mandala is the graphic and atomic structure of the whole cosmos and is the modified version or representational version of the Pranava Veda. The exact center of the 64 squares is called Moolam or primal dot. The primal dot is square in shape and has within itself the presence of 64 squares and within those 64 squares is another primal dot with 64 innate squares with primal dot ad infinitum. (Dr.S.P. Sabharathnam, p xi, Mayan’s Aintiram)
7. Each module or pada within the 8x8 structure resonates with a specific Space Time, Light, Sound and elemental frequency based upon its position in the Space/ Time continuum. This frequency is called a luminous body or devata. This devata has particular attributes based upon its position and qualities in the Space/Time continuum (placement among the 64 sub-cubes or padas).

While the above are just static images, it is important to remember that this is a very dynamic process. Each of the bands around the central nucleus are

vibrating frequencies in constant motion fluctuating and pulsing in a specific rhythm that creates a whole structure that is in constant motion.

This 8x8 Manduka is a vibrant structure of primal Space, Time, Light, Sound, Air, Fire, Water, and Earth. It is the manifested movement of rhythm or frequency over the space of the mandala constituted of 64 squares that gives rise to Form. What we have thus far is the invisible process of manifestation. Now we move to the visible process – while invisible to the naked eye, it is never-the-less the transformational process that leads to the formation of all material objects.

The 8x8 grid – Manduka mandala - is the fabric of the Unmanifest universe.

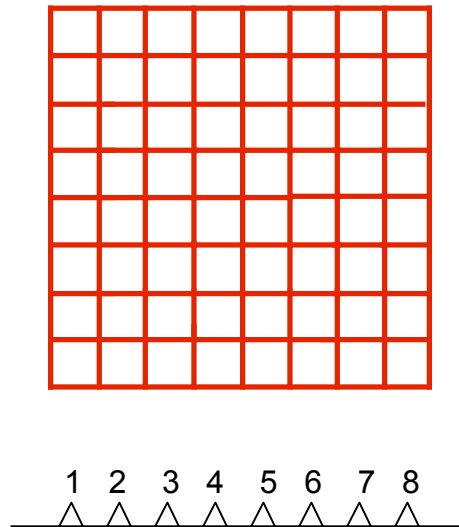

An interesting point to note is that each string of modules represents a pulse/beat creating rhythm or frequency in the Absolute Space/Time continuum. 8x8 modules= 8 beats. This rhythm or frequency exists in the form of sound and light waves.

Understanding the full scope of the meaning of “Time” is of utmost importance for it reveals the principles at play in the underlying causal force responsible for the genesis of the material world. Time can be viewed as a noun indicating frequency or beat and as a verb transitive indicating a process. We have discussed Time as a frequency; let us now discuss Time as a transitive verb.

Time or Kaalam/Kaala as a process

We think of Time as having to do with minutes ticking by on a clock. With this definition in mind, Mayan’s writings can at first be confusing unless a deeper understanding of the word “Time” is discovered. Mamuni Mayan refers to Absolute Time as Kaalam or Kala. He says that it is Time that creates, maintains and destroys. As I investigated this word, I asked many Indians what they took the word Kala or Kaalam to mean. Without hesitation, they all answered, “Time.”

Knowing the deep significance of every word used by Mamuni Mayan, I felt compelled to dig further into the meaning of Kaalam. Many dictionaries reported that the meaning was "time." One dictionary, the Cologne Online Tamil Lexicon gave a deeper and much more significant meaning to the word kaala: 1. to mix, unite, join; to commingle, combine; to be absorbed, 2. a process.

Elsewhere, I found the meaning to be "to flow as one".

I find this to be very revealing in light of what Mamuni Mayan says and what is written in *Fabric of the Universe* based upon his writings. It is written that the 8 gunas/elements grow from one another as a result of Time. Time is described as a pulse of movement in Absolute Space. As a result of that movement or pulse, OM Light arises. As Time and OM light commingle and flow together within Space, OM Sound arises. Space, Time, OM light, OM sound commingle and "flow together" forming Air; then all of those co mingle forming fire and so on.

When Mayan uses the word Time or Kaalam, what he really meant is that Time is a process in which Absolute Space commingles with itself and creates OM light, which commingles with space and manifests OM sound, etc. And all of those individual elements mix, unite and flow together ultimately manifesting as the material world. Here we are given a deeper insight into Mayans meaning of Time or Kaalam. When we see "Time" written what is really implied is that it is a cosmic process that has the elements of mixing, uniting and flowing as one. It is this mixing, uniting and flowing as one that is the creator, maintainer and destroyer of all things. Thus, the notion of Time becomes a concrete scientific term that describes a scientific process fundamental to Vastu Science, the science of manifestation.

Dr V. Ganapati Sthapati provides another view of Time that deepens ones understanding even more"

"The vibration of this OM light is called Time or Kaalam. The vibration of the primal OM light is the dance of Lord Shiva and that of sound is Uma. Hence 'Omkaara' Natana. Uma is 'word' (vaak) and Shiva is 'meaning' (artha). So, Mayan says that Kaalam is the creative element of all the objects of the universe and adds that the universe itself is the product of Time. "Time is the creative source of all objects. It is time that changes into form. It is time that blossoms into the universe and Kaalam thus does wonders"-Mayan. Therefore, Kaalam itself is designated as Kaala Brahman. Kaalam, in simple words is the speed or vibration of energy or light. The summum-bonum of these discussions is that vibration causes all phenomena. This concept is extended to poetry, music and dance where Kaalam is redesignated as Taalam, maatra or kaalam, the ruling element of all forms of poetry, music and also dance. What would be unique and astonishing is that the same Taala measure is

extended to create visual material forms (time-spaces) of which one is the building whether it is a temple or house. Sculptural representations are also born of this scientific theory of rhythm (Taala) and therefore they are divine and worship worthy.”

Temple Architecture: The Living Tradition
Dr. V. Ganapati Sthapati

Exploring the meaning of Time further, the etymological meaning of the Tamil term “kalam” is to put forth, to give rise, to impel, to incite and urge on. It is in fact the vibration of Space that puts forth or gives rise to the manifest world and thus this vibration of space is referred to as kaalam or “Time.” Space and its vibrating state called Time are really one – they cannot be separated as Time or Kaalam are in fact simply scientific expressions of Absolute Space, or Brahman on the move. This movement is Divine Rhythm. Yet, it is in the same breath a scientific principle underlying the physical and non-physical world.

Throughout Mayan’s writings he refers to Kaalam as “Time God.”

Mayan says:

“It is Time that creates; it is Time that maintains; it destroys; it conceals; it sets right the discordant and impropportionate aspects and effects purity; it makes the fruits fructify; it stabilizes; it assimilates; it provides an effective and great path; it brings into effect a supreme and sacred form” (Aintiram: 815, Dr. S.P. Sabharathnam commentary)

The deep meaning expression ‘viditthuk-koduttha’ denotes the orderly behavior of divine energy. It is this orderly behavior underlying viditthuk-koduttha’ - the manifestation of the unmanifest. It is Time that functions as part of this process.

It is only because of Time or frequency (movement of consciousness within itself) that Space or Brahman manifests itself into material form. Time is in effect, simply Space or God itself moving - vibrating. Mayan says that it is Time that functions in every living being as in - breath and out - breath. Time is the dance and Space is the dancer. They are one and the same. Thus, we have the concept of Time God.

Mayan says in his Pranava Veda verse one:

“Om Light and Om Sound are the Primal Source of all manifest forms. Om Light is aroused by its own effort in a state of disorder and appears as a flame. The state of Om Light and Om Sound in Space is a magnificent luminous six - faced Light form that is called “murukoli”. The transformation of Om Light and Om Sound through the five stages is concealed in the five fold knowledge, of which, this is the first. This process of transformation of disorderly Om Light and Om Sound into orderliness is found in all five fold material forms.”

The growth dynamics of the unmanifest Fabric of Creation in values of eight and steps of five:

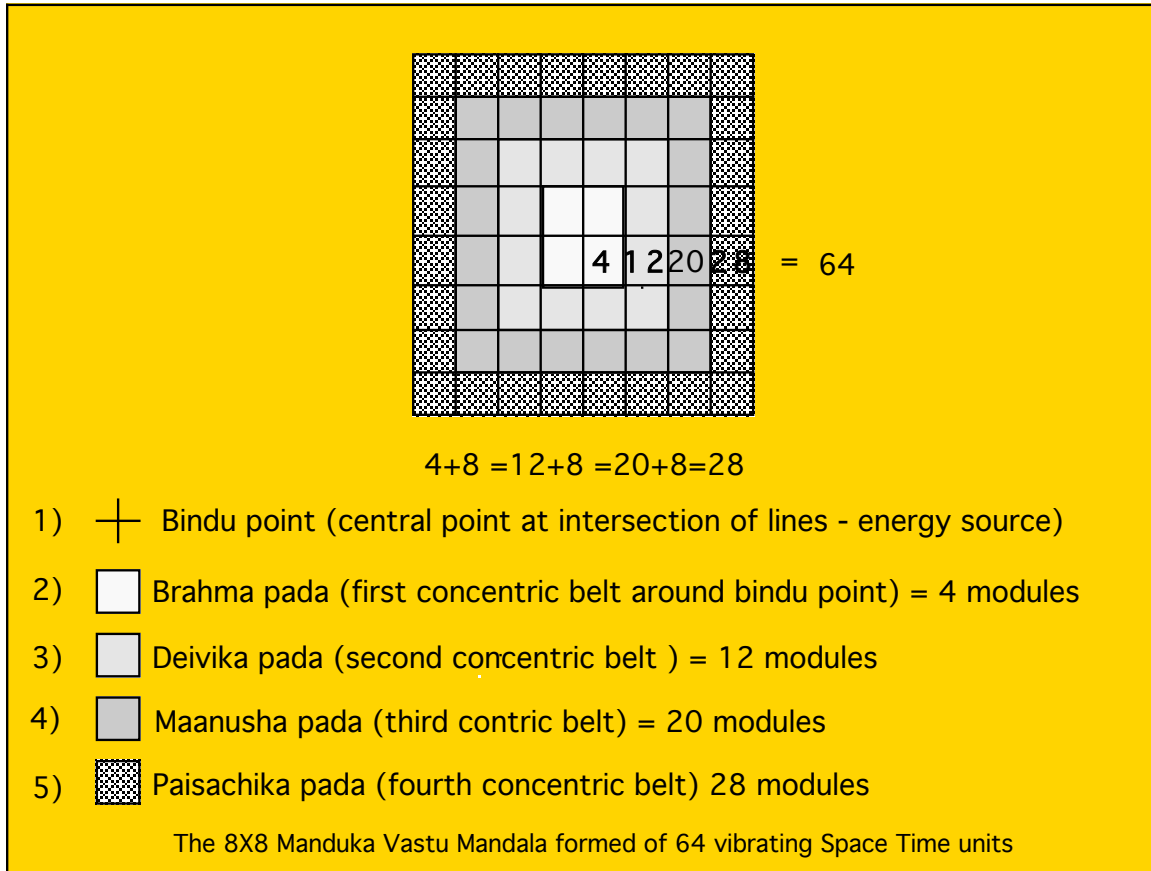

By observing this process of manifestation two dynamics of manifestation are evident:

1. Manifestation occurs in additive values of eight ($4+8=12 +8=20+8=28$ with a total additive factor of 64).
2. Manifestation occurs in sequences of five steps known as the Pentadic Order.

In other words five stages occur with an additive numerical frequency of eight:

(1) The subtle energy point in the center becomes a self effulgent energy generator pouring out waves of energy by (2) becoming a self spinning stabilized structure of four padas/modules then (3) adding eight units of energy to manifest the 4X4 structure of 16 units or modules; then (4) adding another eight units of energy to manifest the 6X6 structure of 36 units or modules; which (5) then adds eight more units culminating in 64 units or modules strung concentrically around the Bindu point or central generator. The entire process produces a total of sixty- four (64) vibrating units with *each* concentric belt having its own

wavelength (4,12,20,28 modules) and waveform and individual vibration while contributing to the sum total vibration of the whole.

(2) These dynamics of manifestation simultaneously and successively produces two other observable phenomena:

1. The elements (air, fire, water, earth- manifested from space), which tend to constellate in the four quadrants of the 8X8 mandala, are produced as waveforms or frequencies – each having specific and different qualities and characteristics. This means that each element vibrates with its own frequency and demonstrates different qualities as a result of its frequency.

2. The outpouring of energy from the central Bindu point distributes concentric modules or padas linked together around itself with each concentric belt having unique and separate square waveforms and frequency. Thus, each concentric belt and the individual units or modules within each belt has its own qualities and characteristics.

While this knowledge is significant of itself, when these phenomena are viewed in light of material manifestation as built space in architecture, the significance becomes stunning and profound.

A vital point here is to consider what the complete form of the 8x8 microabode looks like. Among other things, we know that it is cubicle and that it has a vertical thread of light through its center. In addition, it is composed of four concentric belts of energy that move outward as the thread of light vibrates. The thread of light is vibrating or dancing primal fire.

Mayan perceived the complete form of the 8x8 microabode as thus:

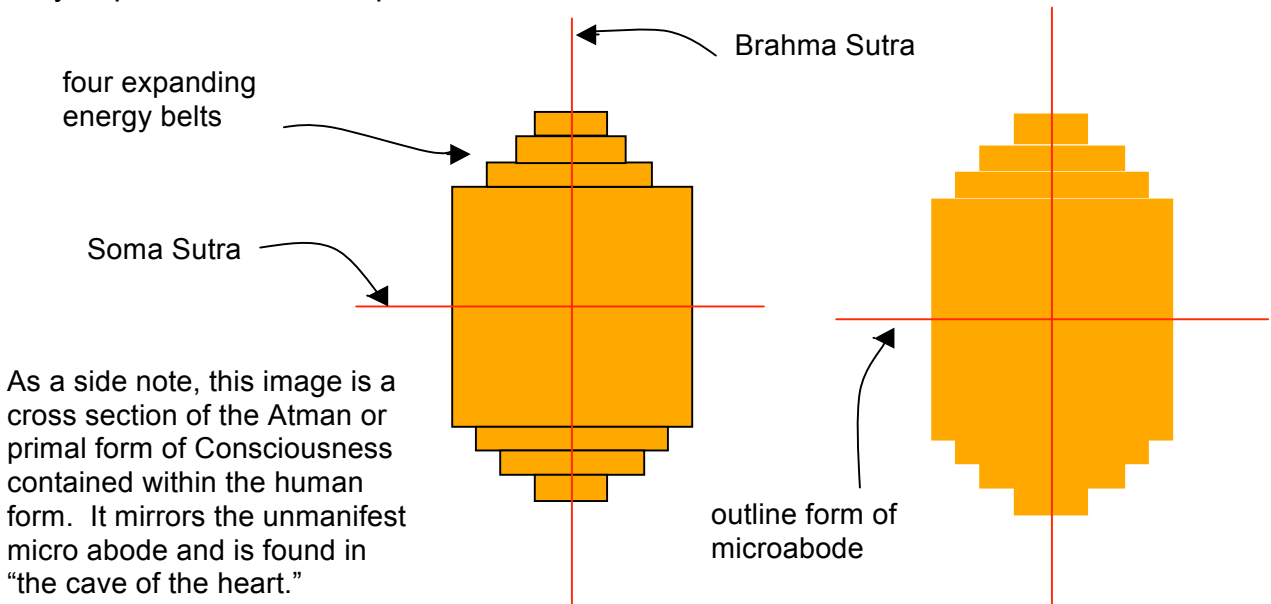

As a side note, this image is a cross section of the Atman or primal form of Consciousness contained within the human form. It mirrors the unmanifest micro abode and is found in "the cave of the heart."

Dr. S.P. Sabharathnam, in his detailed translation of Mayan's Aintiram said, "The most important scientific theme ensouled and explained in this work is the

concept of microabode, the basic space-cube which gives rise to the emergence and existence of Primal Space, Time rhythm, form, and matter.”

This is a vital moment for the reader to please stop reading this section and go to **Appendix A** for additional information relevant to the early stages of this process. Then continue on below.

3.

Eight Equals Nine: The Relative Theory of Manifestation

Understanding the mystery of how Unmanifest Vastu becomes manifest Vaastu rests in understanding how the fabric of the unmanifest – the 8x8 cubicle form - becomes the fabric and fundamental structure of manifest Vaastu - the 9x9 cubicle form.

We see confirmation of the details of this manifestation process outside the Mayonic literature in Chapter 9, verse 8 of the Bhagavad Gita where Lord Krsna describes His manifestation process to Arjuna:

“prakritim svaam avastabhya visrijaami punah punah”

“Curving back onto myself, I create again and again...”

(Interpreted by Maharishi Mahesh Yogi, Interlaken, Switzerland, 1976)

As the 8X8 cubical Manduka mandala continues to spin through Space and Time, it begins to take on different shapes.

Those shapes begin with the square, which transforms itself into a polygon, and then a circle. The circle then transforms itself back into a cube/square with one more string of sub cubes making a 9x9 cubicle structure described in the following pages.

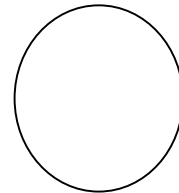
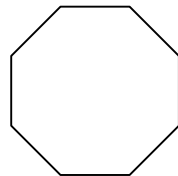

Fully formed 8x8 Manduka continues to spin.

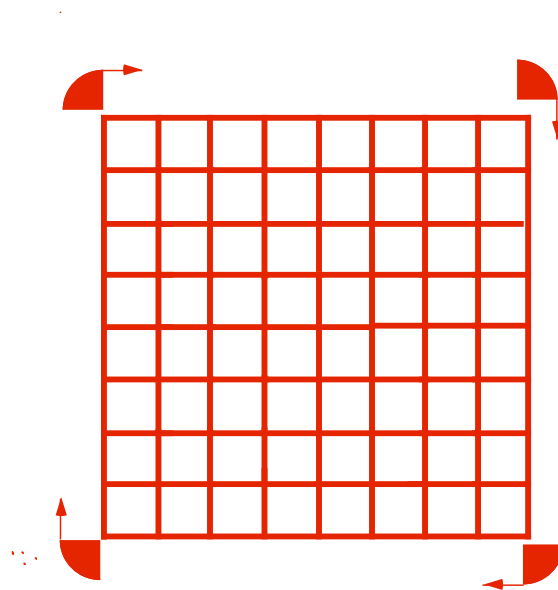

The sheer velocity of the spin and the collection of the elements in the corner padas cause the corners of the cube to curve into its self.

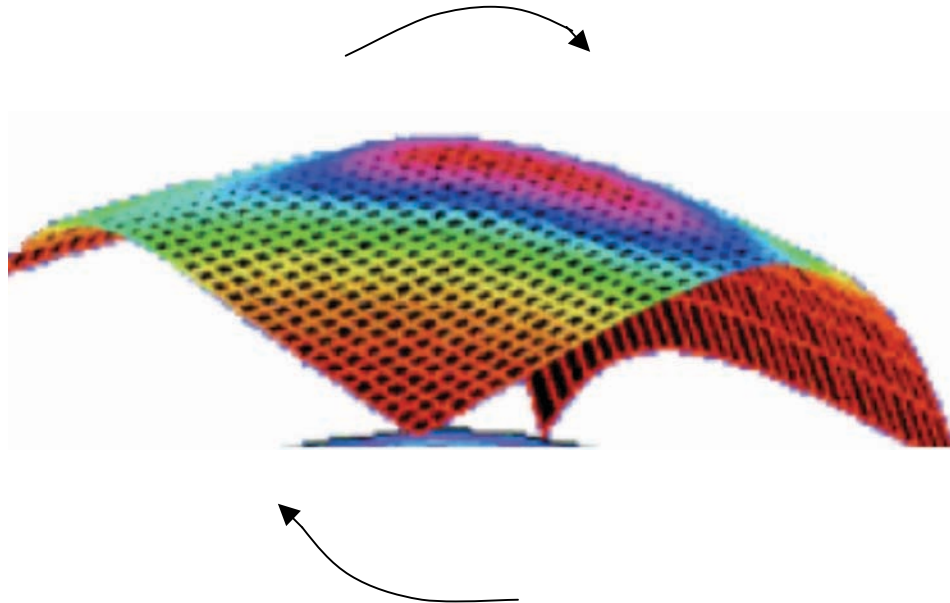

With this curving back onto its self, a octagon form takes shape.

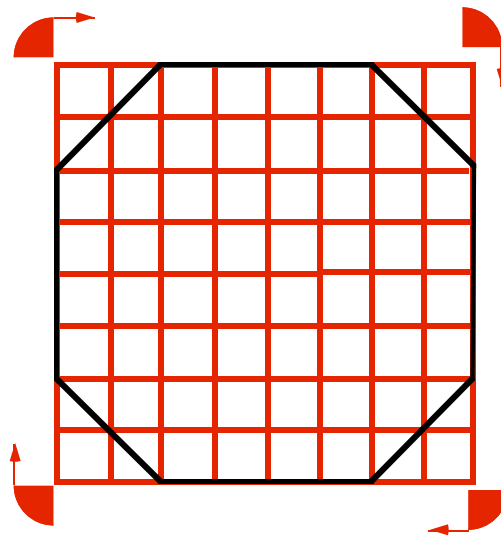

“Curving back onto myself, I create again and again...”

The corners of the octagon also fold in or curve into their selves forming a transitional polygon shape.

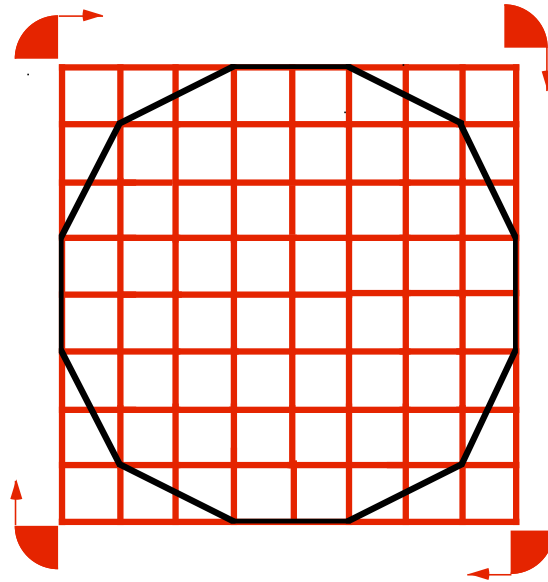

The spin and inward curving continues creating a dynamic circle.

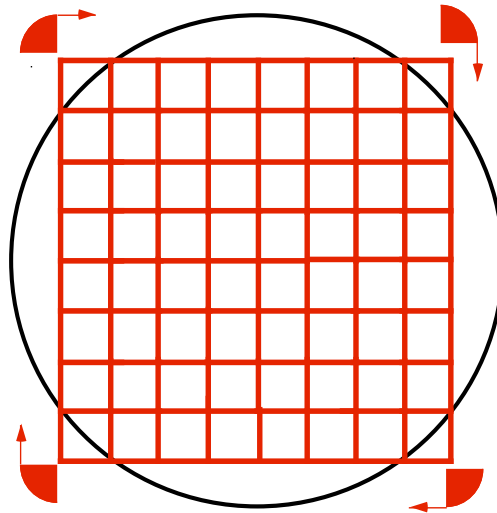

These three primal forms, square, octagon, and circle, have distinct and individual qualities. They form the mass through which the material world is created. They are called the three gunas or qualities.

The perfect square form is called Satwa; the octagonal form is called Rajas; the circular form is called Tamas. A visual summary of this is presented by Dr. V. Ganapati Sthapati in *Building Architecture of Sthapatya Veda* presented below:

MECHANICS OF SUBTLE ENERGY TURNING INTO GROSS ENERGY

(The turn of subtle into gross.)

$$E = mc^2$$

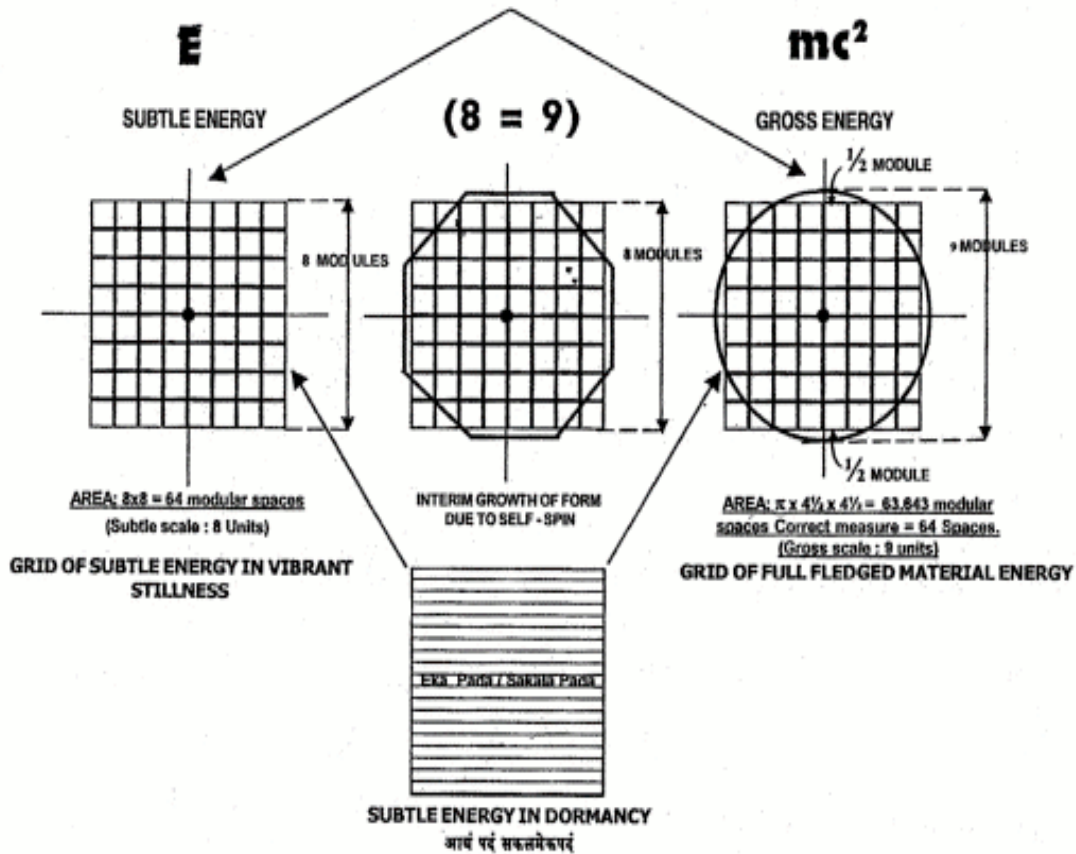

THE PRIMAL MANIFEST FORM OF THE PRIMORDEAL YASTU.

IT IS SQUARISH AND OF MINUTEST PARTICLE OF SPACE.

TRIDimensionALLY IT IS THE STRUCTURE OF OM - LIGHT AND OM - SOUND.

TO PUT IT IN MODERN TERMINOLOGY, THESE ENERGY CUBES ARE BUILDING BLOCKS OF THE UNIVERSE AND INFACIT, THOSE ARE THE MATERIAL FORMS OF THE UNIVERSE AS WELL.

From Dr. V. Ganapati Sthapati, Kauai, 2005

From the expression and co-mingling of the three gunas, a new grid emerges as the grid restores itself into 9x9 cube of tranquility and stillness. This transformation from the 8x8 cube to the 9x9 cube is called Pranava. This

transformation is signified by the 8x8 Manduka Mandala (frog) leaping into existence as the 9x9 Paramasyika Mandala (Vaastu Purusha Mandala).

The 9x9 grid (cube) is the fabric of the manifest universe

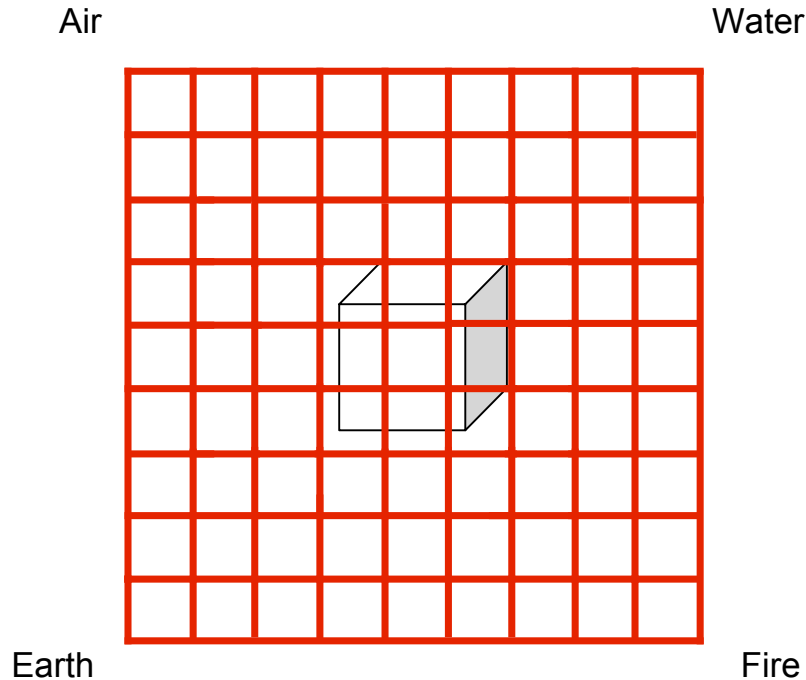

Note here that the strings of modules form pulse/ beat and rhythm/ frequencies, known as “time units,” in the Space /Time continuum.

The 8 pulse or beat of the 8x8 has transformed into a 9 pulse or beat changing the overall rhythm or frequency of the cubical form. This frequency of 9 beats or pulses becomes important in Vaastu as the frequency of a vastu structure is articulated through numerical functions discussed later as ayadi calculations. (It is useful to remember that while these diagrams are shown as flat squares, they are in reality six sided cubes.)

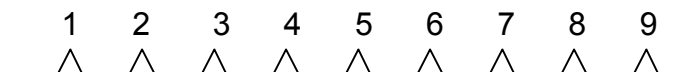

Mayan says, “Those persons who have analyzed the subtle nature of TIME should contemplate the potency of the Primal Existence and realize the manifested movement of rhythm over the space of the mandala constituted of 64 squares which gives rise to FORMS...They should analyze the visible process of the gross aspect of the mandala and the invisible process of its subtle aspect.” ((Aintiram, vs. 177)

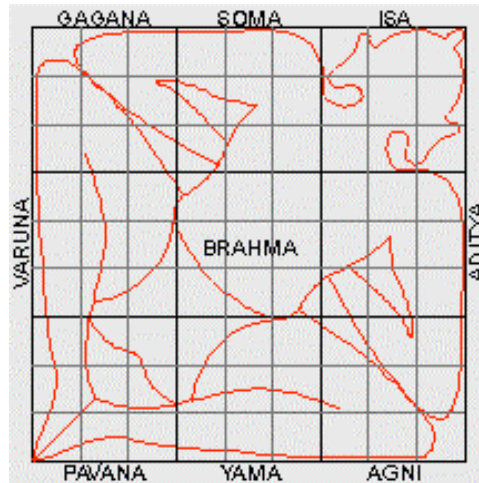

Vaastu Purusha Mandala in its traditional form.

There are several important points to note:

1. There are 81 modules or padas within the 9x9 cube. Each module/pada within the cube is of equal size and shape. Within each module or sub – cube, the process just described (formation of Time, OM light and OM Sound, Air, Fire, Water etc.) is occurring on a miniscule level and mirroring the original process that we have discussed.
2. The original micro-cube continues to spin and expand through Space and Time. The elements of Air, Fire, and Water and Earth are formed. Space organizes itself in cubes that mirror the original micro cube. These cubes are strung together forming bands around the central point. Remember that the origin of the micro cube was a pulse in Absolute Space. This pulse caused the onset of Absolute Time. Pulses in Time linked together form rhythm; rhythm through space forms frequencies; frequencies form meter or beat; frequencies and meter/beat have a numerical equivalent; the numerical equivalent can be translated into specific qualities based upon the length of the beat and frequency just as the length of a string on a musical instrument produces different qualities of sound when plucked with varying beats.
3. The individual horizontal and vertical lines contain the potency of primal light and sound in the form of frequency.
4. The frequencies created by the cubes strung together form Space/ Time bands around the central module or “pada” that expand outward as each element is created. These are bands of energy or frequency that have

- particular attributes based upon the elements that predominate within these bands.
5. The cubical structure of the 81 squares of the mandala is (as is the 8x8 mandala) the graphic and atomic structure of the whole cosmos. It is the modified version or representational version of the Pranava Veda. The exact center of the 81 squares is called Moolam or primal dot – sometimes referred to as the Bindu point. The primal dot is square in shape and has within itself the presence of 81 squares and within those 81 squares is another primal dot with 81 innate squares with primal dot ad infinitum. (extension of the idea presented by Dr.S.P. Sabharathnam, p xi, Mayan’s Aintiram)
 6. Each module or pada within the 9x9 structure resonates with a specific Space Time, Light, Sound and elemental frequency based upon its position in the space/ Time continuum. The position in the time/ Space continuum is determined by the commingling of Absolute Space, Absolute Time, OM Light and Sound, Air, Fire, Water, Earth, and the three gunas. This vibrating frequency is called a luminous body or devata. Each devata has particular attributes based upon its position and qualities in the space/Time continuum (placement among the 81 sub-cubes or padas).
 7. The 9x9 module is made up of fractions of time units. These time units are expressions of frequency.
 8. Frequency, because it is moving energy, can be measured. The time that it takes to move through space from the steady zero state to its peak state and back to its steady state can be mathematically defined. Thus, the frequency of any given 9x9 module can be described in mathematical terms.
 9. The basis of frequency and ultimately Form is Absolute Space /Time and OM Light and OM Sound. Om Light is the foundation for all Visual forms and OM Sound is the basis of all aural forms. This principle includes the human form. “Viewed deeply, it is to be understood that the power of primal light is indeed the power of consciousness in each and every soul.” (Aintiram sutra189)

Mayan describes this entire process in the Pranava Veda and the Aintiram. He describes individual time units, and the progression of their growth into larger and larger units, as modules or padas are strung together. Mayan says, “The minute fraction of time-unit becomes the basis for mathematical calculations...” (Sutra 176).

Second only to the discovery, through introspection, of the manifestation process, Mayan discovered that he, as a scientist, sculptor, carpenter and architect, could replicate this process of manifestation by creating enclosed space. He discovered that wherever he created enclosed space the manifestation process would occur and give rise to energy within that space. He discovered that the variations in all of creation were due to the changes in

frequency of the Primal Existence (vastu) and ultimate mathematical nature of the manifold forms in creation (Vaastu).

He also discovered that the qualities and behavior of the many forms in creation varied due to the mathematical formula equated to any given form and the arrangement and predominance of the elemental factors. With this discovery, he understood that The Primal Existence does not differentiate between good and bad. It just is. It manifests through its own process creating various forms/frequencies that are harmonic permutations of Itself. However, an individual form may be disharmonic to another individual form. For example, one variety of plant may not enjoy growing next to another kind of plant, while it might thrive next to a third kind of plant.

Furthermore, Mayan discovered that he could create and control the qualities generated by a form (sculpture, house, poem, music, dance) by applying specific mathematical formulas to the creation of that form. Mayan discovered, for example, that he could apply his mathematical formulas to building a house. Depending on the formula used, that house will be harmonic to a human inhabitant or it will be disharmonic to that dweller. If a house was disharmonic, it could affect the life of the person in a negative way. If it was harmonic, it could affect the life of the dweller in a positive way.

Striking a tuning fork and holding a still tuning fork of the same chord next to it can demonstrate this process. The still tuning fork will soon be vibrating as a result of being placed next to a vibrating tuning fork. In that same way, the vibration or frequency of the built space will cause the space of the dweller to vibrate at the same frequency of the house. Mayan realized that for a human to be at peace, enjoy health, and experience spiritual bliss, he or she should dwell in a structure that vibrates with those qualities.

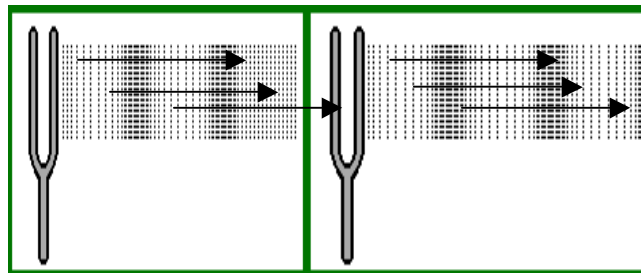

4.

What is Vaastu Science?

The purpose of Vaastu Science is to give form to consciousness. That is, it is the transformation of consciousness into visual and aural forms governed by the science of Time and Space using Light and Sound as raw materials.

Vaastu Science is the application of the principles of manifestation (Vastu Science) to the material world. When the principles of Vastu Science are applied to forms of art, music, dance, poetry and architecture, the form (art, music, etc.) becomes directly resonant with the positive qualities of Pure Consciousness or Absolute Space. That resonance of positive qualities is in turn transmitted to the viewer, listener, or dweller.

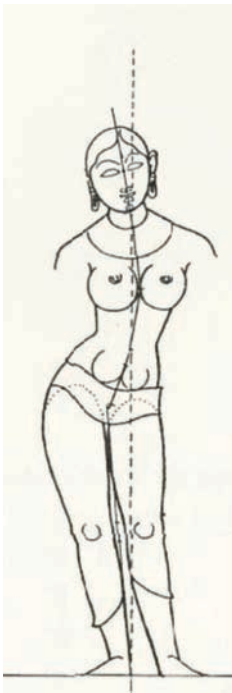

“In the heart of the cave of the body there is an inner space and in that inner – space there is the vibrant thread of consciousness. It is this thread of consciousness that functions as the string of the sarira-vina (bodily instrument)...

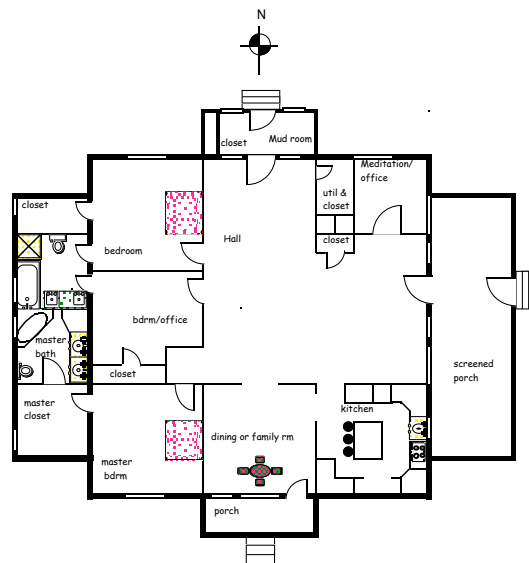

The structure of the Vaastu inspired building vibrates with cosmic energy and the bodily instruments resonates with this vibration.”

Dr. V. Ganapati Sthapati

Design by J. Mercay

“...if a part of free space is isolated and confined into a four walled structure called building, it becomes a living organism and the space enclosed will start vibrating in a particular order. If such a building is designed to vibrate in the same numerical order, as that of the indweller, the resultant phenomenon is that, he will experience harmony or perfect union with the Universal Self...”

Dr. V. Ganapati Stahpati

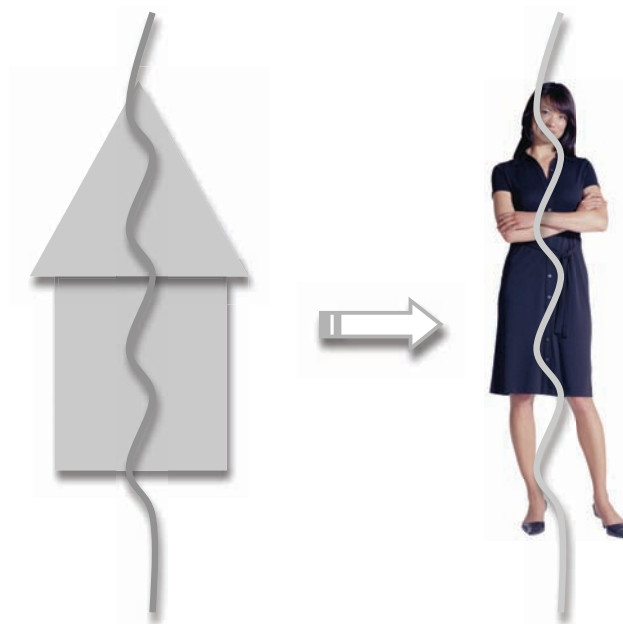

Please stop reading at this point and **go to Appendix B** for additional information on what I call the Mayonic Code. Understanding the information in this appendix will amplify your understanding of the previous information and then deepen your comprehension of the importance of the application of Vaastu Science to Architecture.

5. Application of Vaastu Science to Architecture



"When inner space and outer space resonate together in harmony then peacefulness, vitality, health, prosperity, and dynamic, ecstatic creativity become the natural order and effortless experience."

Brhamarishi Mayan, circa 10,500 BC

Photo: Dr. V. Ganapati Sthapati by Michael Borden

"The Universal Space, when bounded or enclosed by a walled structure, assumes negative and positive qualities, just like the human being possessing a particle of the universal space (called inner space / inner being) does exhibit positive and negative behavior during its life time.

The Vaastu Shastras attempt to calm down all negative qualities of space by arranging the built space in a scientific way. The individual or individuals living in such a well defined space experiences peace and bliss. This wards-off all illnesses attributable to Space. Hence Indian architecture is said to be therapeutic." (Dr. V. Ganapati Sthapati, Contributions of Viswakarmans to the Science, Technology & Culture of Indian Origin, 2000, Appendix II).

When the 8x8 grid becomes 9x9 it forms the basic energetic structure of universe. When followed through in the construction of built space that built space reflects the energy of the cosmos.

Creating positive, life supporting and spiritually enlightening effects requires knowledge of specific rules of Vaastu Science. Those specific rules have been

meticulously delineated in the writings of Mamuni Mayan and translated and applied by Dr. V.Ganapati Sthapati in his Building Architecture of Sthapatya Veda, Dakshini Publishing House, Chennai, Tamil Nadu, India, second edition 2005.

This book is not an attempt to offer a detailed discussion of the rules and procedures in applied Vaastu Science and Technology. However, some of the rules will be described below as an example of the application of Vaastu Science and Technology to building architecture.

The scientific knowledge of Mamuni Mayan extended from the innermost, smallest particle of the unmanifest to the outermost largest conglomeration of particles in the manifest world. Within that entire range, Mayan was able to note the size of what scientists today call the atom. He accurately predicted and measured the size of the earth's mantle. In addition he noted the movement of the planets and constellations including the qualities and characteristics of what are called nakshatras (27 celestial bodies that have frequency and numerical equivalence). He was an expert at understanding vibration and frequency.

Mayan discovered that the earth is a spinning structure that mirrors the spinning of the micro cube and 9x9 grid. Just as the nature of the 9x9 grid is to be composed of an energy grid, the earth also has as its nature an energy grid.

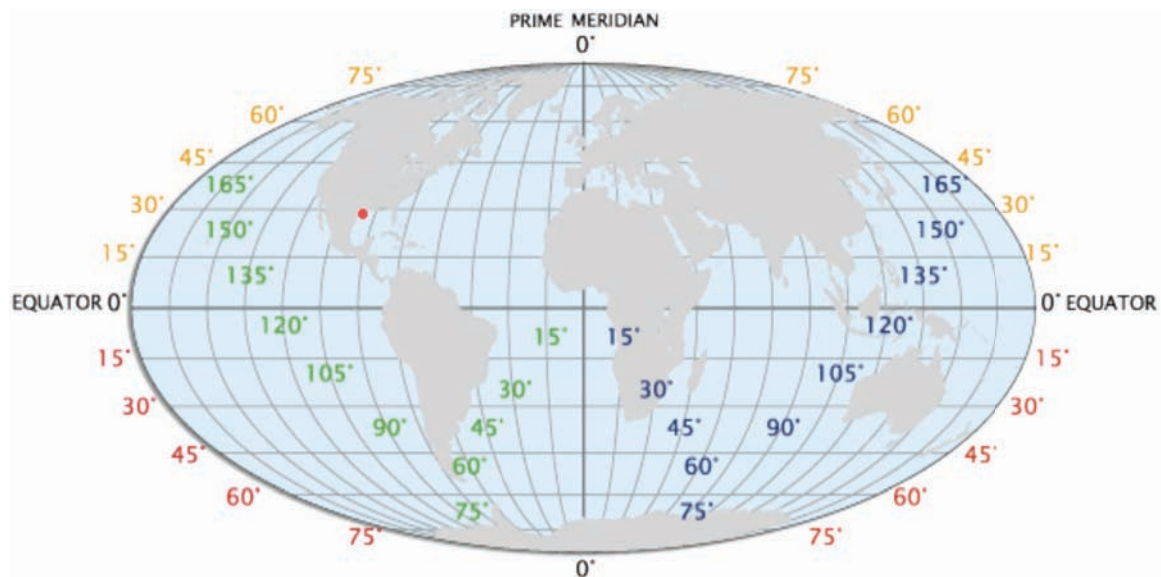

Because the grid lines of the earth energetically mirror the grid lines of the 9x9 and subsequently the 8x8, they resonate with the frequency of the cosmos. Mayan discovered that if built space is placed directionally on the earth's grid, then the space will also vibrantly resonate with the frequency of the cosmos. The following are the principles of Vaastu Science that apply to the grid.

The Earth Grid

- The earth has a flow of energy that is called “the grid.”
- This flow of energy is related to the earth’s rotation at the equator.
- It flows North and South in alignment with true north rather than magnetic north.
- When a house or structure is aligned precisely with “The Grid” the effects of Vastu are realized.
- Another value of using the grid is that solar energy flows east to west as the sun moves across the sky. When a home is properly aligned with the north/ south grid it is automatically aligned with the east west grid.
- Grid lines in a built space are carriers of energy values and qualities.

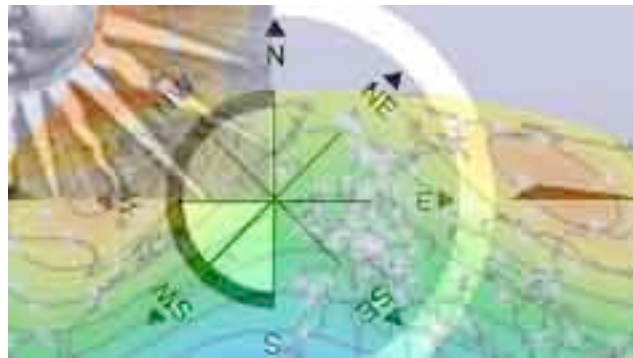

Mayan also applied his understanding of the effect of mathematical values creating varying frequencies and qualities in any given built space. He formulated specific calculations – Ayadi calculations - that are applied to the perimeter of a built space called a *mother wall*.

Building Measure: the yardstick used to give form to consciousness

The Ayadi calculation is the calculation used to determine the size of the main wall or motherwall of the Vaastu structure –home, office, or temple. In the past, the Sthapati used a stick thirty-three inches long divided into twenty-two segments 1 3/8 inches each or twenty-six angulas. This was the standard of measure for temples and homes. One of the names given to this stick is “hasta.” It is interesting to note that Hasta refers to the hand. Elephants with facile trunks are called Hastin or “having hand.”

This reference to the hand is an indication of the importance of the human body in relation to Vaastu Science and Technology. inch described here. The body inch, angular or viral is the length of the thumbs first joint - approximately 1.3/8 inches. Another measure used is from the top of the thumb to the base of the thumb (a measure for deities) which is approximately three angulas or 3 times 1. 3/8 inches (4.1/8 inches). Another measure equivalent to three angulas is a hand width from the base of the thumb to the base of the outside palm. These

are all measures based on the hand – hence the Hasta. Thus, the standard of measure for the Vaastu house or temple is that of the human body.

Not everyone has an exact body inch of 1/3/8 inches. This is determined by Mayan to be the body inch of the ideal person who vibrates with the divine. Rather than using the individual human body inch to build a temple or house, Mayan used the Divine measure – the perfect body inch of the divine – 1.3/8 inches. In that way, the imperfect human would come into resonance with the divine. These measures are pure measures that arise during the orderly transformation called Vastureva Vaastu as Absolute Space takes its form as the material world and its manifold objects.

Ayadi Calculations: Measures of Light and Sound That Bring Spiritual Peace and Comfort

Spiritual calmness, spiritual bliss and material well-being are the most sought after goals of human kind. These are the qualities offered by buildings created by the use of principles of Vaastu Science and Technology. Manifesting these qualities requires knowledge of unique mathematical formulas articulated in the tradition of Vaastu Science and Technology.

These formulae consider the perimeter of the temple or house, the ratio between the length and the width of the perimeter, the height of the ceilings/ walls, the height and pitch of the roof, the size of windows and doors, the size of open space in the center of the temple or house, and more. The Shilpis of India have kept this secret for millennia.

The fundamental measure from which many of the above measures are derived is called Ayadi Calculation or Ayadi Gananam. This calculation forms the core of Vaastu Technology and was known as **Vaastu rahasya – secret of Vaastu**.

“The harmonious resonation of the wave length of the building with that of the inmates is the main aim of Ayadi Gananam.” (Dr. V. Ganapati Sthapati; Ayadi Calculations, 2003)

Ayadi calculation is a measure of the exact size of the container that encloses space. Space is filled with vibrating energy particles. When Space is enclosed, the size and shape of the boundaries that enclose that space and those particles determine the frequency in which the space vibrates.

If four walls such as in a building enclose energetic space, the building becomes alive with that special energy and becomes a living organism with rhythmic vibrancy determined by the Ayadi measurement. Just as we humans feel and vibrate with cosmic essence, the Temple or house also feels and vibrates. A specific Ayadi calculation is chosen that has a known rhythmic vibration that promotes spiritual bliss and material well-being. The calculations chosen will

resonate those qualities our own inner vibrations and by this resonance the dweller of the house is able to be in harmony and communion with the universal space (Mayamatam) and to experience spiritual bliss.

“The use of arbitrary length and width measurements are to be avoided. Or else, it would cause disorder in the energy flow within the built space.” (Dr. V. Ganapati Sthapati; Ayadi Calculations, Mathematics of Vibrational Matching, 11/2003)

If a house or building is not built according to the divine measure cognized by Mayan and if the inner spaces are wrongly designed (according to proper rules of design) and the spaces are improperly designated in terms of use, then the house becomes a source of innumerable difficulties and hinderances for the inmate.

The concept of visible and aural forms is explored in Pranava Veda, and Upanishads such as Tejo Bindu. Tejo Bindu describes two Brahmanas – Sabda (sound) and Para Brahman (light). This Upanishad echoes Mayan's assertion that to understand the material world you must understand the unmanifest world. Like that, Tejo Bindu asserts that to understand Sabda (sound) you must understand Para Brahman (light). Implicit in Mayan's statement is the concept that the unmanifest brings forth the manifest. And, implicit in Tejo Bindu, light brings forth sound.

Understanding that light precedes sound, helps us to understand that sound has its basis in inner vision. This inner vision is likened to intuition and is subtle in nature. It is this inner vision that brings meaning to the sound that we hear. This meaning is really only derived by the action of the Unmanifest Pure Brahman. It is awareness itself. When we allow ourselves to be quiet inside we can experience our own inner awareness – inner vision – Brahman. This awareness is called Artha Brahman or Vastu Brahman by the shilpins. Vastu Brahman is called Oli in Tamil – meaning light

The Luminous Being (Artha) and the Sonic Being (Sabda) are the raw materials from which material light and sound emerge. And, it is actually this Luminous Being Oli that is at the root of it all aural and visual forms in the manifest world. It is Primal light or Luminous Form that is in fact called Vastu.

How do both of these events occur? They occur through a grammar or mathematical order. It is this mathematical order, along with design principles based upon this order that is the secret of Vaastu Shastra. This knowledge is so important and potent that according to Mayan “If the proportionate measures fall short of / are reduced, then there would occur severe diseases and if the ordained measures get increased, then the one who commissioned the shilpin for such

designs would be ruined, therefore, by all means and efforts, one should design the forms according to the lineaments prescribed.”

What is the causal element of this mathematical, grammatical, Mayonic order?

Mayan says that it is the rythmic pulse of Para Brahman (free from vibration). First we have Para Brahman which then begins to pulse or vibrate. That vibration is called Tudi, which takes on the name Time. Time implies rhythm or moving pulse. This Time (Kala Brahman) emits OM light. Everything is implicit in Para Brahman. But then as Para Brahman begins to vibrate, it differentiates itself into time, OM Light, OM Sound etc.

As stated earlier in this text, this unfolding process occurs in a mathematical order. It is this mathematical order that manifests all of the innumerable qualities of the manifest world. Just as light rays for the color blue have certain qualities that arise from a certain length or mathematical equation, all other qualities of light and sound have their own mathematical wave length. Through Ayadi calculations, we can determine the mathematical wave length (the perimeter of the main wall of the house -motherwall), which will give rise to qualities that will support human growth and physical and spiritual well being.

Red cube forms mother, wall. (design by M. Borden)



The Mother Wall

- The “mother wall “ is the primary wall or container that serves to create a space for Consciousness to become conscious - for Vastu (unmanifest energy) to become Vaastu (manifest).
- In a home, for example, it is often the main four walls of the house.
- We call it “mother wall” because it forms the structure that gives birth to Vastu becoming Vaastu.
- The mother wall is constructed on a 9x9 grid and is formed with very specific measurements that cause the central pada (module) to exude specific life giving qualities that then vibrate through the whole structure. It is through this form that consciousness, Purusha, takes the form of its container.
- The dweller then begins to vibrate with those same qualities just as a

vibrating tuning fork of one pitch causes another tuning fork of the same pitch in close proximity to vibrate.

The calculations used to form the mother wall are called Ayadi calculations.

- The Ayadi calculation is chosen to be an exact mathematical calculation that scientifically equates to the personal resonance/vibration of the dweller.
- With the Ayadi calculation, a number of factors are considered in determining exactly what size the mother wall must be in order to resonate the effect of consciousness becoming conscious within the dweller when he or she enters and resides in a specific house. This is a vital piece of information that supports the fullness of the Vastu effect.
- Once the Ayadi calculation is determined, the structure is divided into 9 by 9 modules. The modules can be square or rectangular. These modules help locate important features such as windows and doors on the appropriate grid lines. This maximizes the positive effect of the grid, solar energies and cosmic energies. Extensions (rooms) of various shapes and forms can be added beyond the mother wall but only in accordance with the mathematical formulas of the Ayadi and modules.

The Brahmasthan

The central point of the structure is the Brahmasthan. It is the central module, and the adjacent row of modules surrounding the central module of the 9 by 9 grid formed by the mother wall (see diagram below).

- It is the nucleolus of space from which and in which consciousness becomes conscious.
- Locating the Brahmasthan is of vital importance in breathing life into a structure.
- This central point can be likened to the nucleus of an atom around which energetic forces revolve.
- Maximum benefit arises when this central area is designed in harmony with the rest of the structure.
- The key feature of the Brahmasthan is that it is an autocatalytic energy generator. The qualities and characteristics of the energy generated (happiness, wealth, health, relational and spiritual bliss, success, respect etc.) are determined by the Ayadi calculation of the mother wall. As described above, these numerical calculations determine the pulse and ultimate frequency of all the modules/ padas and the Brahmasthan. The properly placed walls act as energy conduits. The sum total of these frequencies determines the vibrational frequency of the structure. The vibrational frequency generated by the Brahmasthan creates the same frequency within the body and consciousness of the dweller.

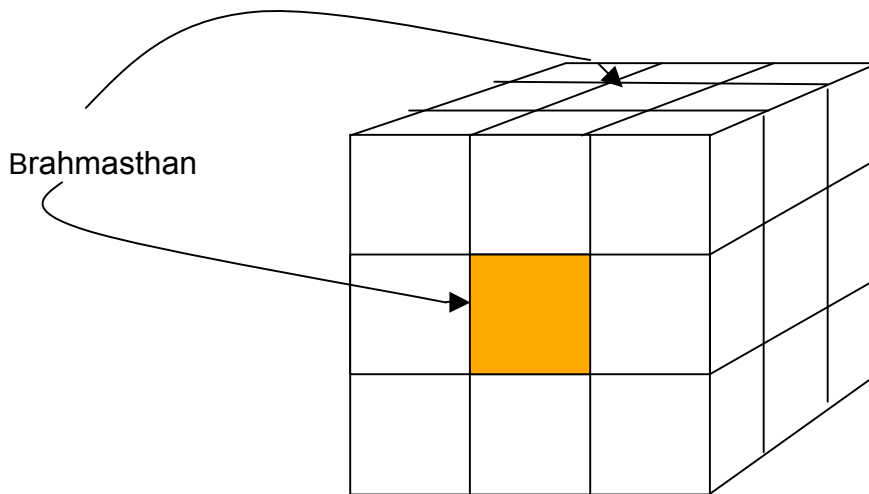

The Five Elements

The formation of the Five Elements (Space, Air, Fire, Water, Earth) is the outcome of the self-effulgent nature of the 9X9 Vaastu Purusha Mandala. Each element was created through the commingling of the previous elements. As the unmanifest microabode progresses through its self spin unmanifest qualities of the five elements are distributed throughout the 8X8 cube. When the 8X8 cube springs forth into material existence, the five elements take on material form and are distributed throughout the 9X9 manifest form in the same pattern as in the 8X8 cube. In the center of the cube (Brahmasthan) Absolute Space mixes with relative/material space. In other words, the unmanifest and manifest coexist at once.

Each of the five elements has specific qualities. The individual qualities of the five elements support specific activities and purposes in human life. In built space where this 8=9 process intentionally occurs, activities of daily life are assigned to and conducted within the quadrants with the qualities most likely to support those activities. For example, if a structure is aligned with "The Grid" described above, the southeast corner of that grid is dominated by the element of fire. Assigning activities related to that element (cooking over a fire) creates a life supporting effect on the results of those activities (preparation of food).

Thus, in a built space reflecting the qualities of Vaastu Science and Technology, the laws of nature and the dynamic energies and vibrations of the elements of manifestation directly support activities of daily living.

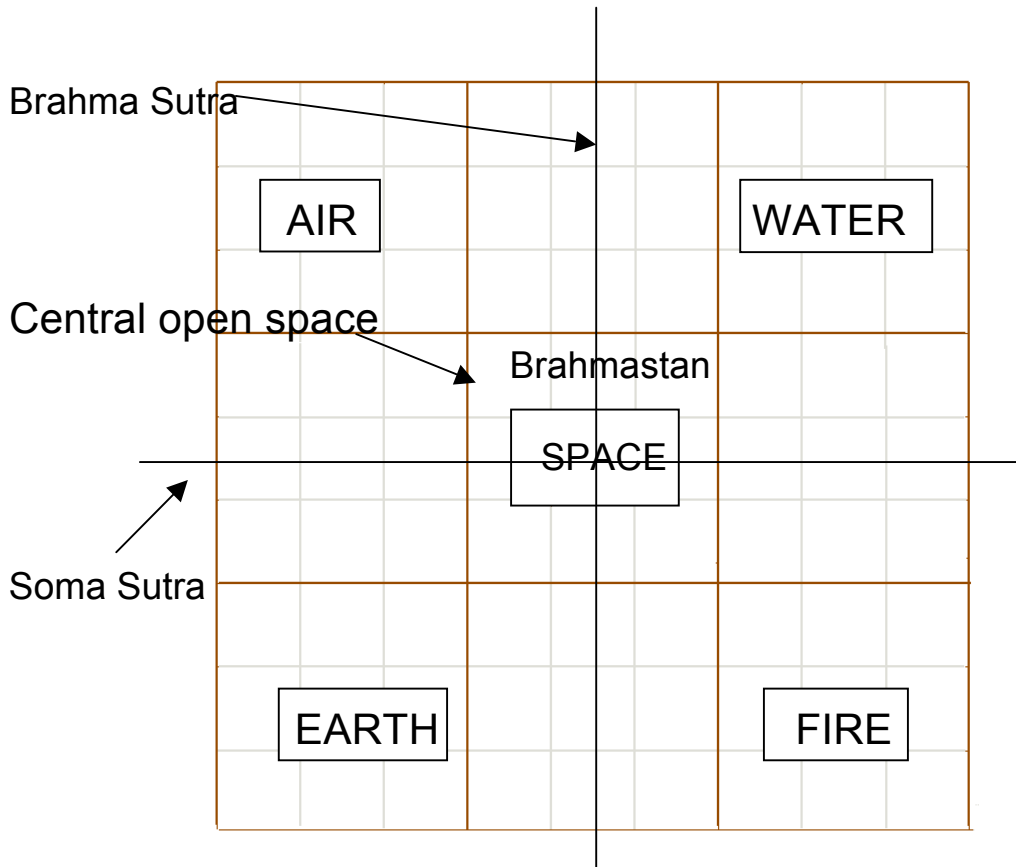

Five elements and Brahmasthan (9 modules in the center of the structure)

The Thread of Light or Brahma Sutra

The Thread of Light is a pathway of light energy that moves through the house in a straight line parallel to the properly placed front door. It flows through the Bindu point or center point of the Brahmasthan. This vibrating energy string is the central cosmic fire from which OM Light, OM Sound, and the Elements arise.

The Yoni Line

The Yoni Line is a pathway of energy that flows from the front door straight through the house to the back door or window - placed directly opposite the front door. It allows for the free flow of energy through the structure. That free flow of energy interacts with the aliveness of the house making the entire structure even more vibrant. When properly placed, the structure lives and breathes harmoniously.

- A point of interest is that in some forms of home design (Feng Sui for example), the house is closed as much as possible to contain the energy. In Vaastu Science and Technology, because the structure is of itself an energy generator, it is appropriate to allow the energy to flow outward through the Yoni Line. The self-effulgent nature of a Vaastu home far surpasses another home in which the energetic patterns are stagnant or otherwise unknown.

The Front Door

The correct front entrance placement is vital to the general effect that Vastureva Vaastu has on a home or structure.

- The placement of the front door determines which cosmic forces flow through the entrance and what the effects are. For example, a main entrance in the northeast quadrant (placed in a very specific, mathematically determined position) is very supportive to health, family relationships, and relationships in general. The front entrance placed in the very center of the south-facing wall creates a harmful effect on the occupants. Moving that door to the module east or west of south center using specific mathematical equations will do the opposite and actually enhance the lives of the occupants. The front door located in the central east promotes egotistical behavior and the demise of children. Whereas if the front door is located one pada to the north of central east it promotes fame and well - being. The front door can be located in any of the four directions but only in the correct module as directed by the Shastras. This effect is due, in part, to the cosmic energy (Vastu) that pours down onto the house from Unbounded Space as it is attracted to the building by the earth's Vaastu. That energy showers the building up to about ten feet around the building (hence the need to ensure that the plot is flat at least ten feet around the building). When the front door is opened, this energy pours in through the door. This is not energy from the stars, planets, sun etc. (all material energy) but rather direct Vastu energy (spiritual energy).

Many people with limited knowledge of authentic Vaastu Shastras do not know that if properly placed, the front door may go on any side of the house. Because they are unaware of this Shastric declaration, out of fear they place the front door only in the east. Again, because they are unaware of the Shastric rules for placing front doors, they place the front door in the central east location. This location for most homes is prohibited as it gives rise to egotistical behavior and demise of children either through death or departure from the home in unhappy circumstances.

Another interesting front door phenomenon executed by uninitiated designers and builders is that they read or heard that the front of the house should be deflected 1.5 degrees to improve material well - being. They interpret that to mean that the front door should be moved 1.5 to 2 inches to the right of center (center of the pada). This in fact creates a disturbance in the Vaastu of the house and can result in disharmony for the inhabitants.

Another common error of well meaning but untrained Vaastu consultants and Sthapatya Ved Consultants is that they rely on a text called the Manasara. The text used is a literary translation by a Sanskrit translator who was unfamiliar with technical Sanskrit. This fact produced a text that is only about sixty percent accurate.

It is only through proper training directly under the auspices of a Shilpi Guru that one can learn these nuances of ancient and authentic Shastric rules. The only organizations in the world that provide that training are Vaastu Vedic Research Foundation (www.vaastuved.com) Chennai and The American University of Mayonic Science and Technology, USA (www.aumscience.com)

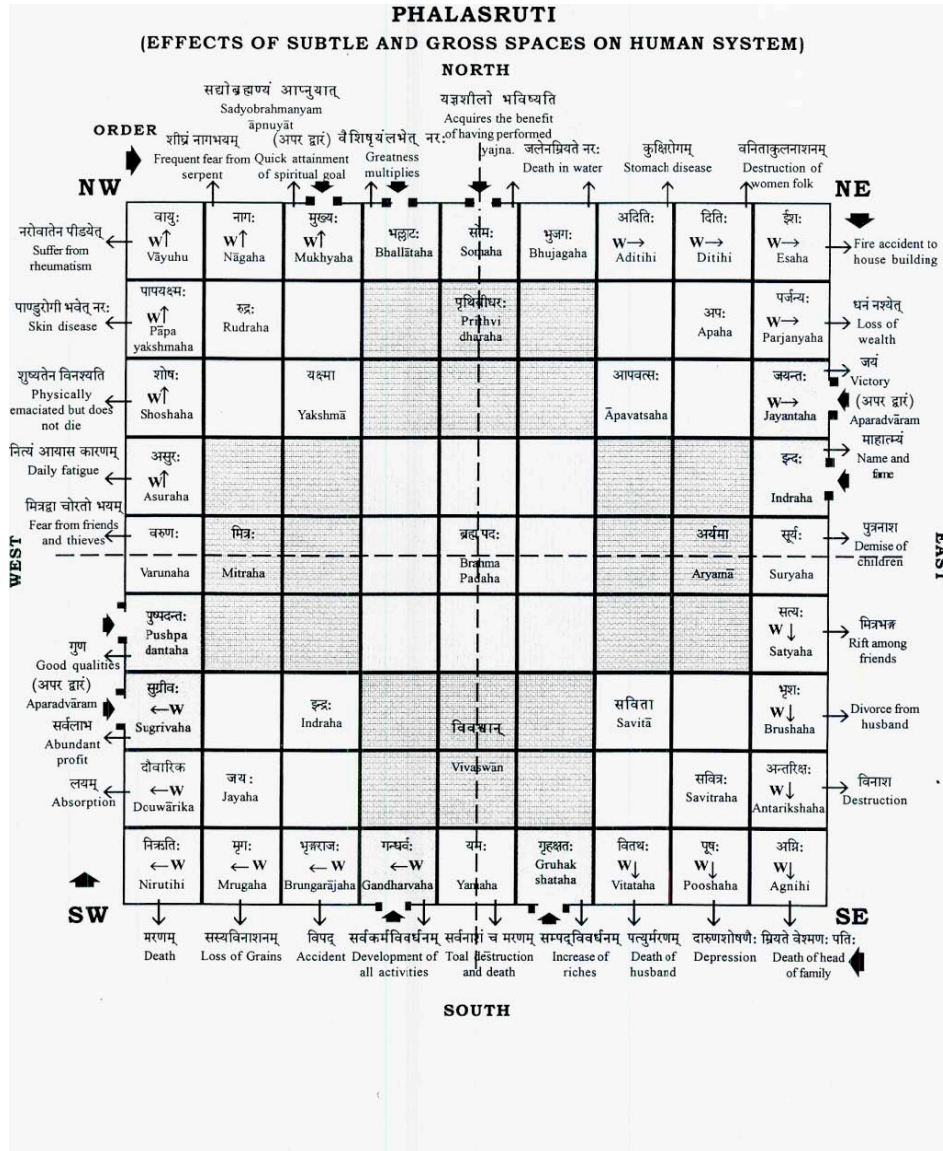

Front door placement indicated by arrows in the cardinal directions.

Other Aspects

Vaastu Science when applied to built space takes other aspects into consideration including: slope of land, flow of underground water, roads, bodies of water, quality of soil, vegetation, flowing water on the surface (streams and

rivers), the flow of water through pipes in the building, ecological building materials, secondary door placements, window placements, elevational factors and much more. The unique aspect of Mayonic Science, the original form of Vaastu Science, is that these considerations are based on mathematics, astro-dynamics, and physics rather than superstition.

The impact of applying these Vaastu principles to a structure (home, office, church, temple, apartment, village, statue, painting, piece of jewelry, etc.) is that that structure, regardless of size, becomes a “living structure.” Living structure means that the structure is vibrating with life giving qualities of consciousness specifically selected for a particular inmate or group of inmates. While the concept of “living structure” is difficult to understand, a story by Dr. V. Ganapati Sthapati, in the documentary film, “A Shilpa Speaks,” might help clarify this concept:

“When my father was working in the Ramana ashram he had to make a statue of Sri Ramana Maharishi. My father was very close to him. He had seen the innermost feelings of the Maharishi on his face. What my father saw, he savored and absorbed. When the work on the image was begun the Maharishi would come every day and look at the progress. As the image was nearing completion, he looked at the statue and said, “Oh! Ramana is here!” Immediately my father put away his hammer and chisel.”

Through the proper execution of Vaastu Science, the statue ceased to be simply a chunk of stone - it became enlivened with the consciousness, qualities, and characteristics of Ramana Maharishi. When Ramana Maharishi witnessed his own consciousness and qualities awakened in the stone he acknowledged that to the Shilpi. The stone had become a “living structure” exuding the vibrational frequency of Sri Ramana Maharishi.

Another way to view this is that animate objects vibrate at a specific frequency in Space and Time. Inanimate objects have their own frequencies as well. The term “living structure” describes the frequency of animate objects. It is as if, when Vaastu Science is applied to an inanimate stone and the stone is formed into a Vaastu structure, it begins to vibrate at the same frequency as an animate object.

According to Dr. V. Ganapati Sthapati, without applying Vaastu principles, specifically Mayonic Science and Technology, the structure, jewelry, art or other object is “sick.” That means that consciousness is not harmonic with the wearer or dweller. In that state, the individual associated with that structure does not experience the possible gain and benefit available from Primal Existence.

The “sick” object or structure can, in some cases, drain the life of the individual and create ill health and misfortune. It is as if the “sick” structure is seeking energy from the owner/resident in an effort to struggle for life. The result is that

the owner/resident begins to struggle for life. In a properly constructed or rectified Vaastu structure, life energy and harmony is added to the life of the owner and occupant.

The entire structure of a Vaastu house becomes a self-effluent living organism that transforms its dweller into a radiant self - effluent spiritual being. A properly constructed built space created through the application of Vastu Science and Vaastu Science brings spiritual bliss to the dweller.

"The embodied energy is Vaastu Purusha Mandala or the Creative Essence made manifest on the physical plane. The space enclosed in a building is Praasaada Purusha Mandala or "energized building." Such a building is a living organism built of musical units of measure. These units correspond with the primal vibrations of the cosmos itself."

Brahmarishi Mayan, circa 10,500 BC

The success of Vastu /Vaastu Science in contributing to the welfare of a home dweller is based upon the fundamental structure and subsequent frequency emitted by that vibrant structure. It is the mathematical formula used in creating the mother wall, the placement of the walls, windows, and the structure in alignment with the earth's grid that is of great importance to the vibrational frequency of the structure.

The use of objects such as mirrors, yantras, crystals etc., that are often used in many Vastu consultations in an effort to "correct" or "rectify" the harmful effects of a disharmonic structure is based upon superstition rather than scientific principles. The thought that a mirror or other object can cancel out the negative effects of the powerful Primal force emitted by a built space is sheer fantasy. The success of a Vaastu consultation relies solely on the ability of the consultant to understand and apply the principles of Absolute Space, Absolute Time, Om Light, OM Sound and the ensuing unfoldment of Vastureva Vaastu.

Mayan said:

"Through the power of inner consciousness, the knower of Vastu should know about light aspects and sound aspects of OM pertaining to both inner and outer space. Those who do not realize the creative dynamism of inner space cannot know the dynamism of outer space" (Aintiram: sutras 195,831).

Once an individual understands the principles of Vastu /Vaastu Science, he or she comes to realize what is truly necessary to build or "rectify" a structure properly and does so in accordance with the authentic principles of Vastu/Vaastu Science rather than with principles based on superstition.

The Builder

Thousands of years of experience have verified that the individuals who undertake the construction or forming of an authentic Vaastu structure (Sthapati, Shilpi, Architect, Vaastu consultant, dancer, poet etc.) develop a yogic intimacy

with the structure or form. The trained Sthapati and the Shilpis internalize these scientific and spiritual concepts so that they impart the maximum knowledge to their construction. Just as the sculptor becomes the sculpture, the architect becomes the architecture, just as the poet becomes his poem.

Our Inspiration

We are in great debt to Mamuni Mayan for his deep insights born of introspection and presented to the world through his writings. In addition, we are grateful for the immense contribution of Dr. V. Ganapati Sthapati for his untiring effort to faithfully translate and transmit this Pure Knowledge of Vastu Science and Vaastu Science.



Dr. V. Ganapati Sthapati



Dr. Jessie J. Mercay

APPENDIX A

Manifestation and The Square Wave: What the blip is going on?

"As in Micro, so in Macro. The whole exists within the minutest particle and the minutest particle contains the whole. The atom contains the universe and the universe contains the atom, and neither exists without the other. Creator exists within creation, even as creation exists within creator."

Brahmarishi Mayan, circa 10,500 BC

Mamuni Mayan discovered that the fundamental form of creation is the cube. This cubical structure is called the micro abode (smallest particle that is the abode of pure consciousness/absolute space/ akasa). The initial pulse in Absolute Space as described in this monograph forms this minute structure.

In examining the dynamics of manifestation we see that manifestation occurs in additive values of eight as described in this monograph. However, one could be puzzled by the fact that the very first "structure" is shown as four units rather than eight. One might be compelled to ask, "If the principle of eights is true then why does the first form only have four space time units?"

If we take Mamuni Mayan's statement above and apply it to current scientific knowledge about the nature of square waves gained through modern science perhaps we can have a better understanding of the subtle formation of the initial 4X4 structure during the manifestation process. In other words, Mayan's law above states in essence that what is in the manifest world is found in the unmanifest world and vice versa. Since we already have scientific knowledge about square waves in the material world perhaps we can apply this to the unmanifest world and the manifestation process. This will possibly help us to understand the peculiarities of the process of manifestation.

The particular issue under consideration here is the principle that manifestation occurs in eights yet the very first module that appears in this text is the 2X2 mandala. It is from the 2X2 structure the principle of the additive factor of eight begins rather than at the very onset of the process. The following may shed some light on this.

Scientists have discovered that when a square wave begins it has a fall equal to its rise. In the figure below, the + point is the zenith (peak) of the rise of the square wave while the - points out the nadir (lowest point) in the fall of the square wave. This represents one full pulse in the square wave.

The diagram below demonstrates this.

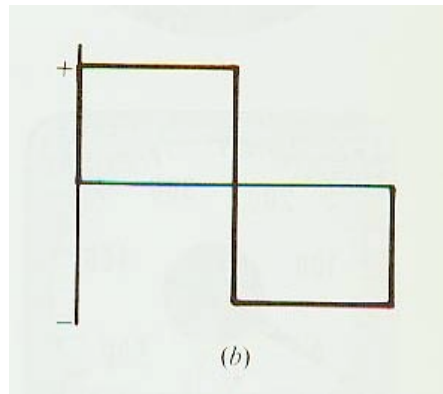

Notice that as the square wave falls to its nadir it proceeds forward in the space - time continuum. Thus the rise and fall of the square wave pulse actually occupies what might be called four units of space within the one pulse. In observing this phenomenon visually it becomes immediately apparent that the single pulse of the square wave actually creates four space-time units as shown below:

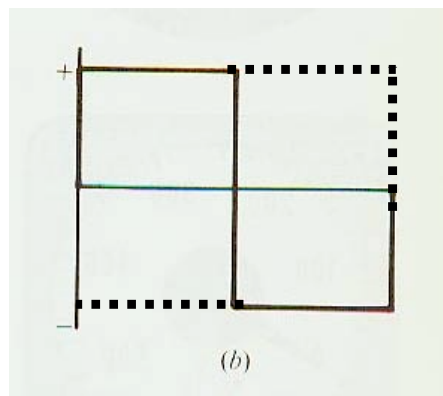

In other words, one square wave pulse could be said to create four space-time units. Hence, we may extrapolate from this that with the first pulse of Absolute Space; four Space Time units are created.

It is as if with one blip or pulse, Absolute Time, Om Light and OM Sound are created (4 units composed of Absolute Space, Absolute Time, OM light and OM Sound) Then manifestation occurs in two pulses at a time (each blip contains 4 Space Time Units or 8 units each in an additive manner) –blip blip (Air); and continues- blip, blip (Fire); blip blip (Water); blip blip (Earth). Eventually forming what is called the 8X8 Manduka Mandala.

In summary, the initial manifestation process begins with the formation of a 2X2 structure formed from one pulse of Absolute Space. It is from that point on that the additive factor of eight begins.

This discussion is merely an attempt to present a theoretical concept designed to reconcile the apparent initial non-conformity to the general principle that manifestation occurs in eights. Future additions or deletions may be made to this

theoretical construct. Note: Below are two demonstrations of the development of the sacred form known as the swastika related to the concept the square wave. It is easy to see how this ancient cross-cultural image was derived.

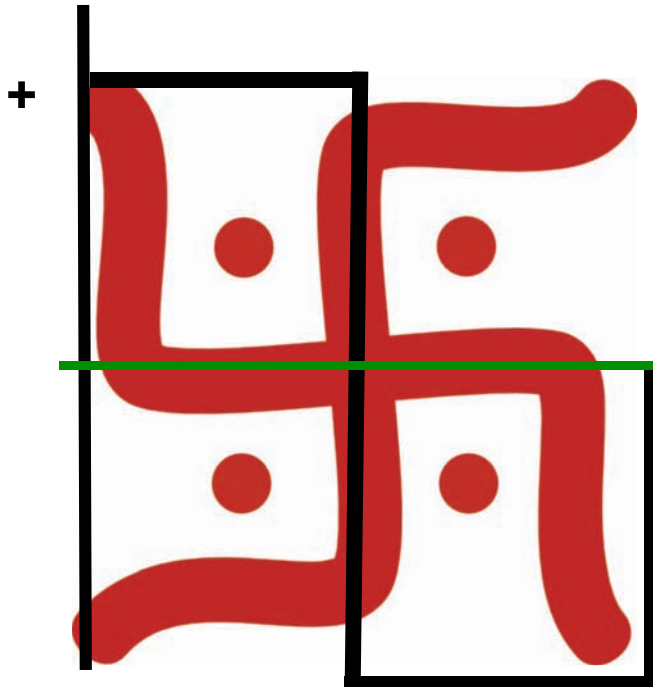
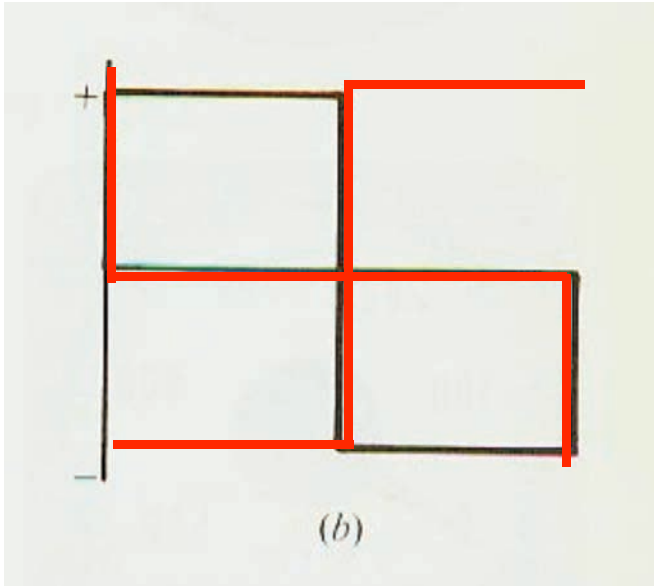

(Please return to the main text and continue with section 3.)

Appendix B

The Mayonic Code: The Physics of Wave Forms and Vastureva Vaastu

Mayonic Science and Technology and its sub topics of Vastu Science and Vaastu Science and Technology are deeply rooted in the science of Physics. More accurately, since Mayonic Science and Technology preceded Physics as a discipline by about 10,000 years one could say that Physics is deeply rooted in Mayonic Science and Technology and it is Mayonic Science and Technology that will ultimately explain the science of Physics. In the meantime, we can use principles of Physics to help us understand the mechanisms and dynamics of Mayonic Science and Technology.

In this discussion, I will present some fundamental ideas found in most basic physics texts and relate them to Mayonic Science and Technology. Physics is the scientific study of matter, energy, force, and motion, and the way they relate to each other. Physics also investigates and elucidates on the physical processes, interactions, qualities, properties and behavior of something.

Mayonic Science and Technology is the science of manifestation of subtle energy into embodied energy. It is the science of manifestation, energy, matter, time, space, rhythm and form. Principles of Physics can be found in Mayonic Science. Mayonic Science extends those theoretical principles of Physics through Mayonic Technology to material applications. The study of Physics will in turn help us to understand Mayonic Science and Technology.

Physics 101

Principle:

- Present day Physics has confirmed that everything in this Universe is composed of vibratory or oscillatory components, be it solid or evanescent (transient/ disappearing). Those oscillatory components are fluctuating waves of energy called sine waves and square waves. The genesis of these waveforms is called a pulse.

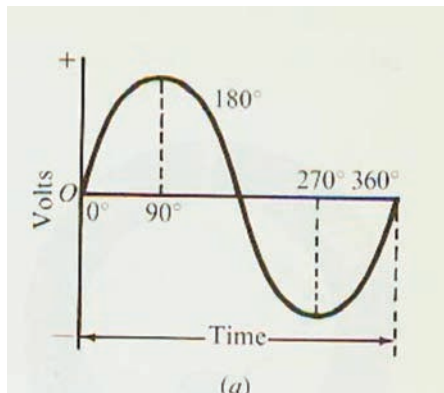

Sine wave

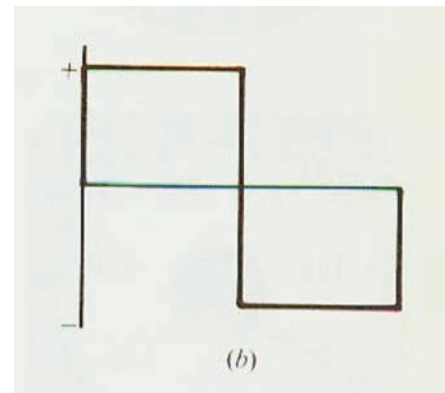

Square wave

- A pulse is a single disturbance moving through a *medium* from one location to another location. One particle is stimulated or pulsed and that particle acts upon adjacent particles. The repeating and periodic disturbance, which moves through a medium from one location to another, is referred to as a wave.

Application to Mayonic Science:

Mamuni Mayan says, “The primal manifest form of the unmanifest is square” He calls it a primal wave pattern- (Aintiram) - the pure energy cube. From this we can say that the most fundamental wave form is cubical / square in nature

Interestingly enough, scientist say that contained within square waves are potential sine or curved waves. If we use the knowledge gained from Mamuni Mayan (As in micro so it is in macro and vice versa) and the facts offered by modern physics it is possible to understand the mechanisms of unmanifest pure energy (Vastu). Why is this important to think about and apply to Vastureva Vaastu?

In understanding that the square wave contains a series of sine waves, if we look at what happens to square waves under certain conditions we might find a clue to the 8=9 phenomena.

Principle:

- The speed of a wave increases with wavelength (the change of speed with wavelength is called dispersion).
- Dispersion causes long wavelength waves in the square wave to move faster than the short wavelength waves.
- As *time* progresses, the square wave is decomposed into a spreading series of waves of different wavelengths. In other words, with increase in amplitude, the square wave spreads out into various wavelengths as it decomposes with increased speed and gives way to sine waves.
- Sine waves are curved by nature and, if spinning, form a circle.

The diagram below shows a square wave increasing in amplitude and speed then decomposing into sine waves.

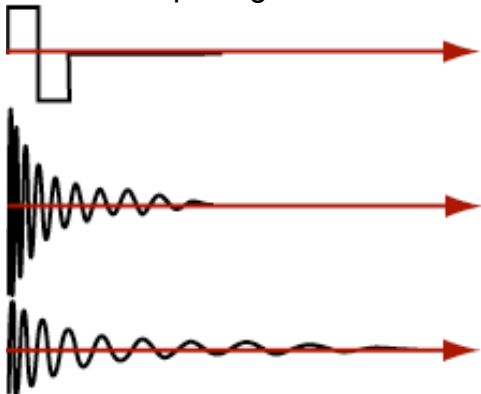

(See Appendix C for more on this)

Application to Mayonic Science:

In the formation of the 8X8 Manduka Mandala, it was previously noted that the concentric bands of time Space Time units (modules or padas) that form around the central Bindu point contain more and more modules (space time units strung together) forming increasingly long bands of energy. In addition, it was established that those bands around the central Bindu point are frequencies or waveforms/wavelengths. During the process of manifestation, wavelength increases additively by eight. That means that there is also a change of speed with the increase in wavelength. It is hypothesized that, as described above, when there is an increase of wavelength, and speed, the square wave becomes dispersed and forms a sine waves. Since the whole entity is spinning it is easy to see how the sine waves could form a circle.

Principle:

- When sine waves interact with each other in a specific way (two sine waves of equal frequency and intensity traveling in opposite directions combine) those waves appear to be stationary or standing still. This illusion is called *standing waves*.

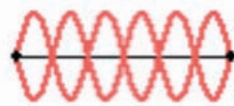

Standing waves

- Waveforms have specific qualities based upon only a very few simple characteristics. Those characteristics are:
 - A. Wave length- the actual length or measure of the wave - length of one complete wave cycle
 - B. Amplitude: the height of the wave or the maximum amount of displacement of a particle on the medium from its rest position - the distance from rest to crest.
 - C. Periodicity: the interval between wave peaks

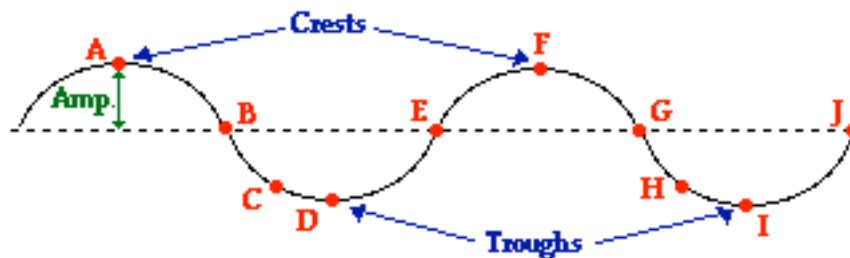

(The units from A to B, B to C, C to D and so on, can be viewed as are Space Time Units.)

- To fully understand the nature of a wave, it is important to consider the *medium* as a series of interconnected or interacting particles. In other words, the medium is composed of parts, which are capable of interacting

with each other. The interactions of one particle of the medium with the next adjacent particle allows the disturbance to travel through the medium

Application to Mayonic Science:

In the case of unmanifest creation, within the fundamental medium called Absolute Space, there are uncountable numbers of cubical particles called micro abode (smallest particle that contains absolute space). When a self activated pulse occurs within Absolute Space, one particle acts upon adjacent particles and ultimately creates a waveform or wave forms. Given the nature of Absolute Space, it would be easy to imagine a holographic waveform. This vibrant but unmanifest energy is called Vastu.

Principles:

Waves are said to be an energy transport phenomenon. As a disturbance or pulse moves through a medium from one particle to its adjacent particle, energy is being transported from one end of the medium to the other. This is the story of the formation (in the medium of Absolute Space) of Absolute Time, OM Light, OM Sound, Air, Fire, Water and Earth as described in this monograph.

An interesting property of wave functioning deals with the results that occur when a wave moves across a medium and strikes a boundary.

- A portion of the energy carried by the pulse is reflected at the boundary and returns towards the source of the wave. (Light energy is reflected back and sound energy is echoed back). The disturbance, which returns to the source after bouncing off the boundary, is known as the reflected pulse.
- A portion of the energy carried by the pulse (about half) is transmitted to the boundary, causing the boundary to vibrate.

Application to Mayonic Science:

In Vaastu Science and Technology we understand that pure wave forms are generated at the center of the Brahmastan and move outward in all directions toward the boundary or mother wall established through the numerical equation of the Ayadi calculation. Because we know that in physical wave dynamics as described above, part of the wave generated in the Brahmastan is transmitted to the boundary or mother wall. The mother wall then vibrates with the qualities generated in the Brahmastan. That vibration is carried throughout the structure creating a constantly vibrating form.

“...if a part of free space is isolated and confined into a four walled structure called building, it becomes a living organism and the space enclosed will start vibrating in a particular order. If such a building is designed to vibrate in the same numerical order, as that of the indweller, the resultant phenomenon is that, he will experience harmony or perfect union with the Universal Self...” Dr. V. Ganapati Sthapati

Square waves of the 8x8 transform into vibrating sine waves represented by Nataraja (dancing Shiva). They proceed out from the center of the Brahmastan in all directions (only one direction indicated below) and pass through space to the boundary established by the mother wall. In following the principle that when a wave hits a boundary it splits. Part of the pulse is transmitted into the boundary and causes the boundary to vibrate and the other part is reflected backward to its source. The part of the wave that moves backward causes a co-mingling or interference with new waves moving forward toward the boundary thus causing standing waves. The amount of wave energy that stays with the boundary is influenced by the medium it is passing through and the boundary conditions.

As the standing waves vibrate, the waves from the 8X8 structure can be said to meet their self in the returning waves. That “meeting of itself” and co-mingling (Absolute Space meeting Itself) creates an additive factor that creates the 9X9 structure of the Vaastu Purusha mandala. In Mayonic Science and Technology, this phenomenon is understood to be the cause of the vibrational nature of a Vaastu form. That is, the mother wall then becomes a vibrating structure that passes this vibration onto the inhabitant. This accounts for the many benefits experienced by people living in Vaastu homes.

Since a properly built Vaastu structure is cuboidal and mirrors the form of Vaastu Purusha, the entire structure – walls and airspace are packed with vibrating microabodes (smallest unmanifest particle that contains consciousness). This accounts for the overall sense of wellbeing experienced by inmates as they begin to vibrate within their own microabode with that of the Cosmic Principle.

Unmanifest microabode vibrating within itself and manifesting as “house.”

House as manifest microabode vibrating with live giving qualities.

Inmate’s microabode (Atman) coming into perfect resonance with vaastu home which mirrors life giving qualities of microabode in Universal Consciousness.

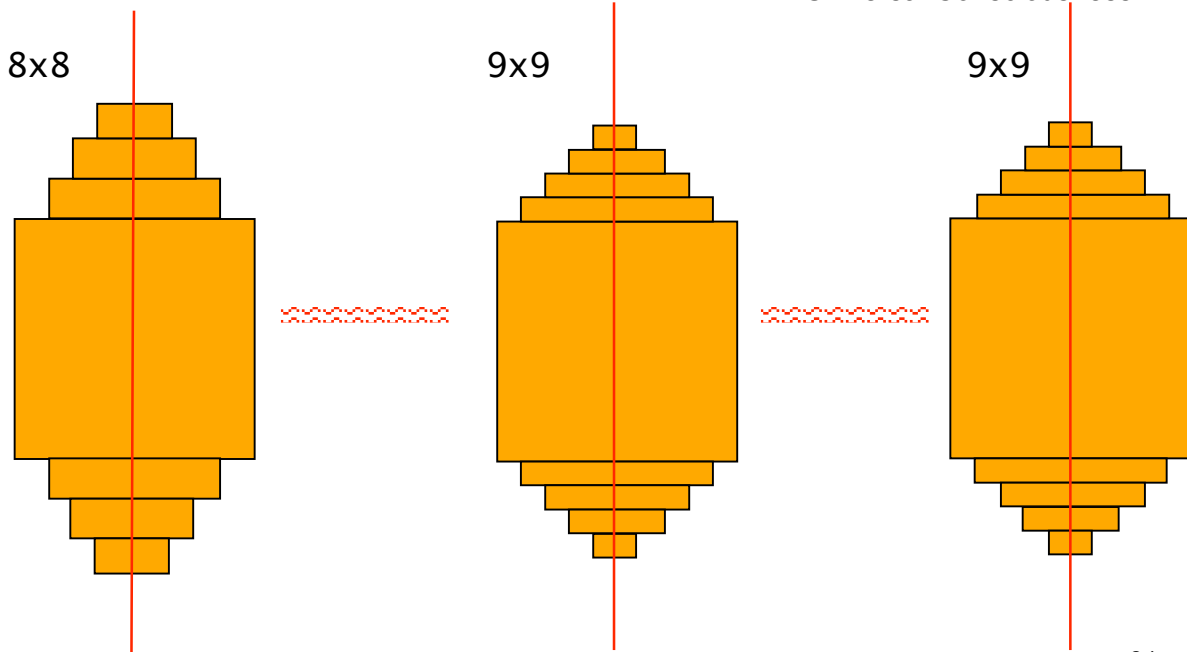

How does this happen? The diagram below demonstrates the mechanics of this phenomenon. And, above and beyond this mechanism, as you can see from the diagram above (three microabodes) the inmate (person) and the house are nothing but Brahmam in bounded form.

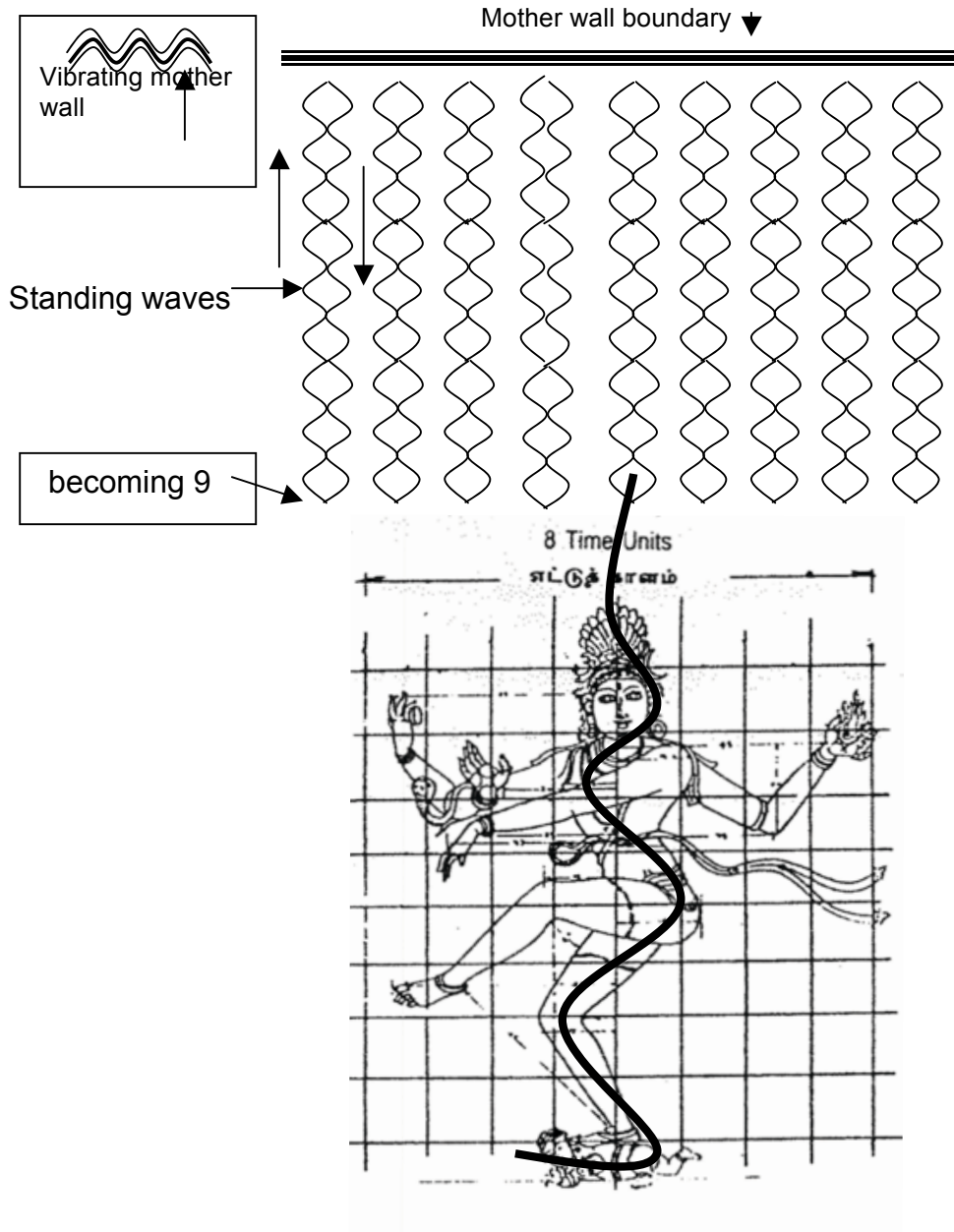

The Code

The transformation from *square waves to sine waves* and back again is the story of the dynamics of Vastureva Vaastu - the 8X8 Vastu Purusha Mandala transforming itself into the manifest 9X9 Vaastu Purusha Mandala and back again.

As this takes place, I suggest that the transformation of 8 to 9 results in the production of *standing waves*. I believe that this scientific principle is encoded in the forms created by Vishwakarmans (Shilpis, sthapatis etc.) using principles of Mayonic Science and Technology. For example, I suggest that the famous Vishnu Statue is one such encoded form. The coiled serpent with many heads (Adishesha) represents/ demonstrates *standing square waves* and *standing sine waves* in their steady state forming a foundation for manifest Vaastu to sustain itself in material form represented by the God Vishnu (Ranganatha). While there may be other meanings associated with this particular statue form, I am suggesting that this might be an encoded scientific meaning.

In review, a standing wave pattern is a vibrational pattern created within a medium (space, stone, clay, architectural structures etc.). When the vibrational frequency of the source causes reflected waves from one end of the medium to interfere with waves traveling from the source, specific points along the medium appear to be standing still. Because the wave pattern appears to be standing still, the pattern is called a "standing wave pattern." These standing wave patterns are only created within the medium at specific frequencies of vibration; these frequencies are known harmonics. In Mayonic Science and Technology the medium is Absolute Space and all of the elements described earlier in this monograph (Absolute Time, Om Light, OM Sound, Air, Fire, Water, Earth) are vibrating frequencies and the materials used to create manifest forms. The vibrational frequency is manifested through the mathematical formula used to create the mother wall of a Vaastu structure/form.

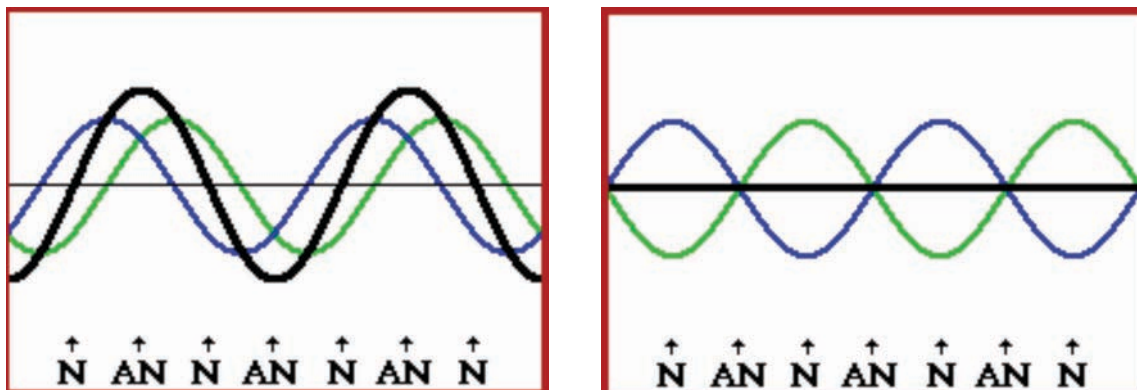

Sine waves interacting with each other causing standing waves.

I believe that in the Shilpic tradition of Mayonic Science and Technology, this (and other scientific principles) was preserved through visual language and visual

mathematics in the reclining Vishnu statue and in the forms of other gods and goddesses.

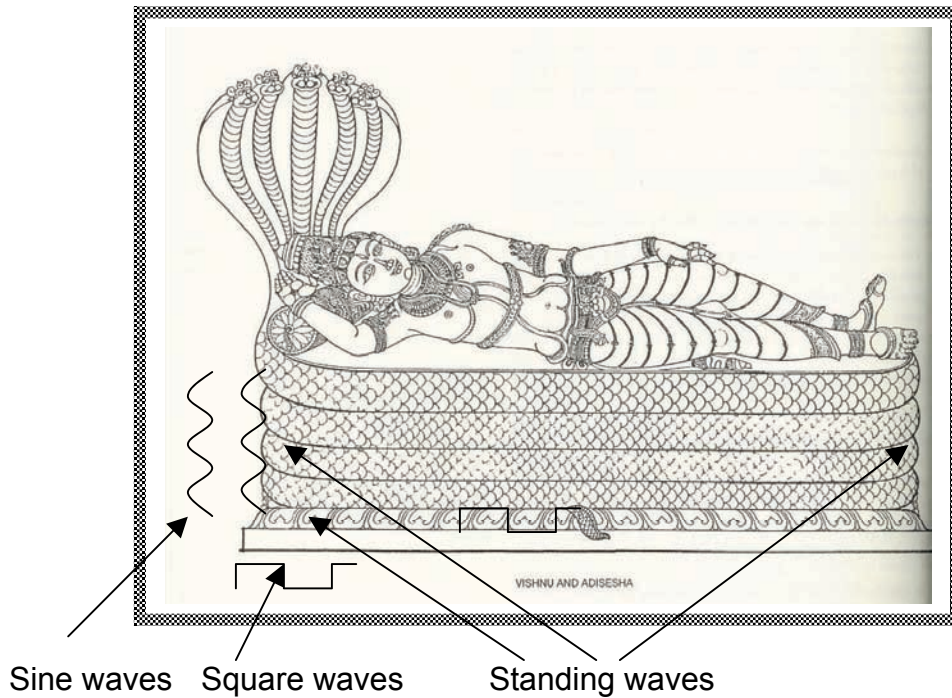

In *Indian Sculpture and Iconography* (Dr. V. Ganapati Sthapati) this is further demonstrated on pages 49-56 where discussion on Nata Manam – measurement of the body in flexion is conducted. The measure of flexion when turned sideways is none but the form of a sine wave. See figure below.

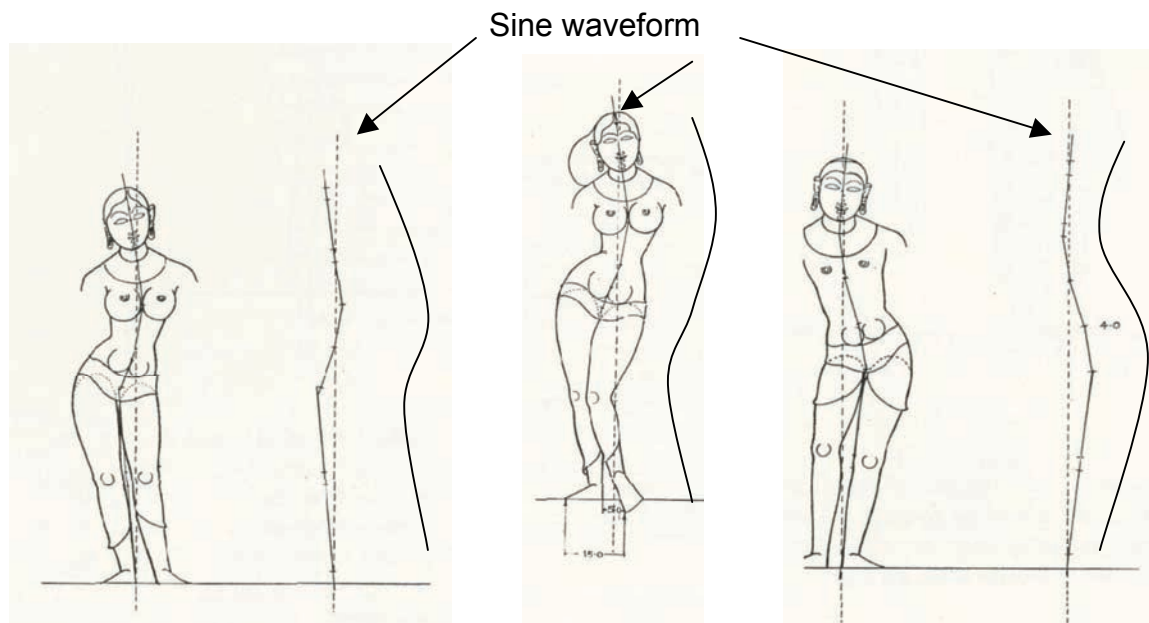

In light of these ideas, Vishnu and other Gods and Goddesses may be viewed as Gods but more appropriately, should be viewed as scientific phenomenon. I contend that this is a scientific principle demonstrated and preserved by the shilpic arts and science- none other than Vaastu Science and Technology.

In the shilpic tradition, the 'medium' is stone, metal, clay, wood, etc., and the mathematical formula used to create the form serves as the boundary that the waves strike and cause vibration.

Another example of the coding of scientific principles in Mayonic Science and Technology is illustrated by the following information derived from the writings of P.V.N. Murthy (Author and Editor: <http://www.vedsri.org/linguamths.asp>)

"Take the 2 words Ganapathi and Shanmuham appearing in books on different topics. Logically, a person reading them from a Hindu religious book will immediately think of Lord Vinayaka with a potbelly, elephant head sitting with a big mouse at his foot and of Lord Subramanya with a three-headed dagger in his hand, sitting on a peacock. It will also come to mind they both have a brotherly relationship. Suppose the same names appear in a pure biography book and a person not knowing any Hindu religious names reads them. No Gods will come to his mind at all. He will only think of some places or persons having these names. Suppose either a religious, or a stranger to Hindu religion, not having any knowledge of science and mathematics reads these words in an actual science or mathematics book and suppose he does not know the subject of the book also. He is sure to get thoroughly confused. The words would appear non-cohesive, irrelevant and do not make a meaningful sentence. He might even mistake them for mysterious 'manthras'. He may fumble upon them in his curiosity to make out something useful. This might substantiate the third possibility. Suppose a scientist or mathematician knowing the exact code of the language in which the book was written reads the same 2 words. He takes the exact meanings:

'Gana' = cubic; 'pathi' = space (or owner of gana); 'Shan' = 6;
'muham' = face.

'Ganapathi Shanmuham' = 6 faces of the cubic space.
Incidentally, this is a mathematical concept in physics that a perfect cube of a given length has 6 faces. This substantiates the first possibility."

So we see that the knowledge of the six-sided Vastu cube (microabode) is encoded and preserved in the statues of Ganapati and his brother.

Another example of this scientific code hidden in the names and forms of Shilpic designs is the description given to the Nataraja or Dancing Shiva shown on the previous page. Traditional practitioners in the Shiva temples adore Nataraja as “Kalacakra Pravartakah.” The translation of this is “the one who wields the clusters of time units and time divisions on various planes.” (Dr. S.P. Sabharathnam, Introduction to Mayan’s Aintiram, p. xv). This clearly refers to the Space Time units discussed at length in this book.

While this information refers to linguistic encoding I would like to point out that language formation and meaning is within the scope Mayonic Science and Technology. The shilpi tradition has used visual language to encode scientific principles and aural language to encode the same scientific principles by naming the forms they create. Their visual literacy is directly connected with verbal literacy. They create in name and form a heretofore-secret scientific code in the forms that have survived the centuries.

This is an extremely exciting era in the unveiling of the secret scientific codes preserved by Mayonic Science and Technology through the Shilpis, sthapatis and other members of the scientist/artist Viswarkarmas of Mother India.

Please return to the main text and continue reading

Appendix C

More On The Formation of Square Waves and Sine Waves

The purpose of the following section is to demonstrate that a square wave can be formed by a sine wave and that a sine wave can be formed by a square wave. This information is relevant to understanding how the 8X8 unmanifest cube changes itself into a 9x9 cube and its ensuing myriad forms of creation and vice versa.

A square wave can be constructed from combining multiple sine waves at different frequencies. The sine waves added in addition to the fundamental frequency are called harmonics; a square wave has harmonics at odd multiples of the fundamental frequency. As higher harmonics are added, the result gets closer to an ideal square wave, which contains infinite harmonics. (<http://www.slack.net/~ant/bl-synth/4.harmonics.html>)

$$\sin(\text{angle}) + \sin(3 \cdot \text{angle})/3 + \sin(5 \cdot \text{angle})/5 + \sin(7 \cdot \text{angle})/7 + \dots$$

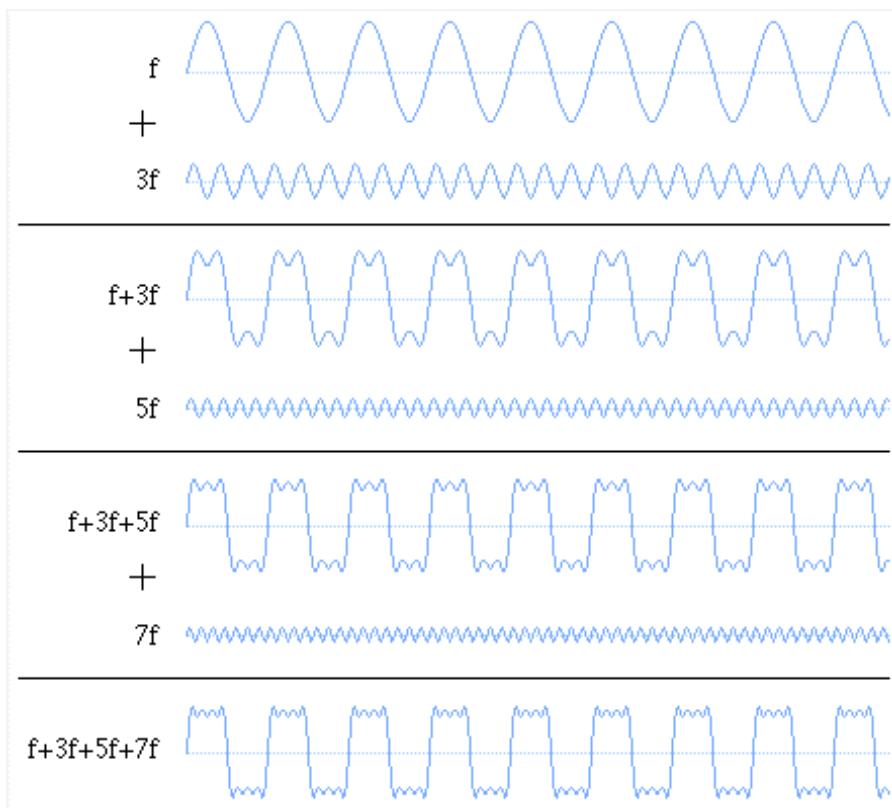

In the same way that a square wave can be created from multiple sine waves, a sine wave can be created/ manifested from a square wave through *filtering* the many sine waves from the square wave. In other words because a square wave is made up of innumerable sine waves, it can be transformed into an individual sine wave by filtering out the other sine waves.

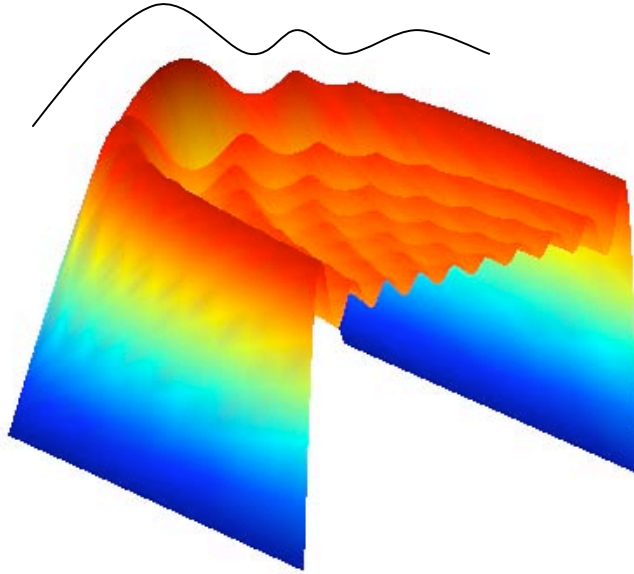

In the process of 8 transforming into 9 we see the formation of individual sine waves from the square waves that form the 8x8. What evidence can we look to test that that theory?

1. The phenomenon of a circle arises during the process. A sine wave has the potential to become circular wave when spinning or stimulated.
2. If we look at the secret formulas of the Shilpis we see the existence of the sine wave demonstrated by their images.

“OM light and OM sound are like huge waves of the ocean of The Primal Source. These waves subside as tiny ripples of normal sound and musical notes. OM light and OM sound belong to the luminous space in which the working system of light energy and space energy are seen.” (Vs 6, Pranava Veda, translation by Dr. S.P. Sabharathnam)

Mayan goes on to say in verse seven, that this primary event is in the form of a six sided cube that has three dimensions (length, width and height). He says that the force of light scatters itself causing luminosity in the cosmos. At this state, the cosmos appears as a beautiful creation. (from Pranava Veda translation by Santhana Krishnan Sthapati, Architect Krithika Karruppiah, confirmed by Dr. Ganapati Sthapati) Note: This is the first time in history that the Pranava Veda has been directly cited in English.

ஓம் ஓம்